

Corryong Courier

Circulating throughout WALWA, KHANCOBAN, CUDGEWA and CORRYONG DISTRICTS

Published by Moscol Group P/L ABN 23 154 875 573. Print Post Approval No. 100002892.

Address: 1/41 Hanson St, Corryong, 3707 / PO Box 32, Corryong, 3707. Ph: (02) 6076 1045

Website: www.corryongcourier.com.au. E-mail: editorial@corryongcourier.com.au / adverts: adverts@corryongcourier.com.au
Single copy \$1.50 (GST inc.) / \$115.00 p.a. posted (GST inc.) / \$74.99 p.a. online (GST inc.)



THURSDAY MAY 19, 2022

\$1.50 INC

Corryong Newsagency

43 - 49 HANSON STREET, CORRYONG
Phone: 02 6076 1381 / FAX: 02 6076 1188
Email: info@corryongnews.net.au



Opening hours: Mon-Fri 5.30am - 5.30pm / Sat 5.30am - 1.00pm / Sun 7.30am - 12 noon / Public holidays 5.30am - 12 noon.

MOVIE TUNES



The Corryong Memorial Hall was rocking on Saturday night to a live stage show 'Blame it on the Movies' featuring iconic songs performed by a five piece band and two vocalists.
Photo: Andrew Kendall

HOURS: Monday to Friday 5.30am - 5.30pm, Saturday 5.30am - 1.00pm / Sunday 7.30am - 12 noon / Public holidays 5.30am - 12 noon.



WHEN THE TEMPERATURE HITS YOU

JUST GET A FUJITSU!

RECEIVE A FUJITSU DIGITAL PREPAID MASTERCARD WORTH UP TO \$450 WHEN YOU PURCHASE THE FOLLOWING:

UP TO \$200 SPLIT SYSTEMS	UP TO \$250 REVERSE CYCLE SPLIT SYSTEMS	UP TO \$400 MULTI SYSTEMS	UP TO \$450 DUCTED SYSTEMS
------------------------------	--	------------------------------	-------------------------------

FREE MONEY WORTH UP TO \$450

* Purchase by 4:59pm AEST 31/08/21. Claim by 4:59pm AEDT 29/10/21. Domestic and residential purchases only. Eligible models only, see website for list. Exclusions apply, see full terms and conditions. Proof of purchase and payment required. Customers will need their outdoor model and serial numbers and indoor model number to complete their claim. Full terms and conditions available at fujitsu.com.au/promotions. The Fujitsu Prepaid Mastercard is issued by EML Payment Solutions Limited ABN 30 131 436 532 AFSL 404131 pursuant to license by Mastercard Asia/Pacific Pte. Ltd. Mastercard is a registered trademark, and the circles design is a trademark of Mastercard International Incorporated. Mastercard prepaid cards can be used at all merchants that accept Mastercard prepaid cards. Terms and conditions apply. Promoter is Fujitsu General (Aust.) Pty Limited (ABN 55 001 229 554) of 1 Telopea Place, Eastern Creek NSW 2766.

Contact us now for more details
Ph: 02 6059 3222
2/20 Mint St., Wodonga

ARCtick
CERTIFIED
AU06286



24-30 Hanson St., Corryong. Ph: 6076 1286

GREAT SPECIALS

1/2 PRICE WAGON WHEELS Biscuits 160-250g Selected Varieties \$2 (SAVE \$2)	1/2 PRICE ARNOIT'S Mint Slice \$2 (SAVE \$2)	50% OFF NESCAFÉ Cappuccino Sachets 6-10 Pack Selected Varieties \$3.50 (SAVE \$3.50)	50% OFF TRESemmé Shampoo or Conditioner 940ml Selected Varieties *excludes Travel Size 740 per 100ml. \$7 (SAVE \$7)
1/2 PRICE Cadbury Dairy Milk \$5 (SAVE \$5)	1/2 PRICE Cadbury Oreo or New! Ice Cream 1.2 Litre Selected Varieties \$5 (SAVE \$5)	Specials end 24th May 2022	

Recovery services continue

Towong Shire Council is working closely with Bushfire Recovery Victoria (BRV) to finalise and confirm recovery resourcing for the 2022/23 financial year.

Council plans to continue its recovery services until June 2023 and is working on the appointment of additional staffing to support recovery needs over this time.

Member for Benambra, Bill Tilley, asserted in Parliament last week that the government should continue to fund bushfire support staff in the Upper Murray.

He claimed that funding for staff employed by Towong Shire under the Council Support Fund would be terminated at the end of June.

"There was no money included in last week's

state budget for this," Mr Tilley said.

Two members of council's recovery team based in Corryong ended their tenure last week, leaving two contacts to support local recovery committees.

The recovery team can be contacted on 1800 518 222 or email jenelle.williamson@towong.vic.gov.au or shea.bloom@towong.vic.gov.au.

Club decides on pokies future

Members of the Corryong Sporting Complex voted at a special meeting last week to purchase its gaming

machines when the current agreement with Tabcorp Gaming Solutions (TGS) expires in August 2022.

The complex board's

preferred option was to purchase the machines outright and for the gaming license to be paid in interest-free instalments over seven years.

The motion to adopt the board's preferred option was carried unanimously at a special meeting, after the annual meeting.

Office bearers and a general committee were elected at the annual meeting where Shane Blake was elected as the new chairman.

ELECTRICIAN
Test & Tag Service

Robbie Burrows
0418 138 674

E: robbie01@igend.com
REC 30313 - mutual recognition in NSW



Holly McLean (left) and Chloe Land put their fire fighting skills to the test at the training day.

The Corryong College CFA team hosted students from other schools in the cluster for training at the recreation reserve last week. The program that has run successfully over many years is now at risk of folding as funding has not been secured beyond this year.

School site to be assessed



The community wants the historic school buildings to be retained.

Plans to develop the former Corryong College junior campus site have progressed following an extensive consultation process which identified that the majority of people want it to be retained for community use.

In February 2020 the junior campus closed and since then, it has been used as the Upper Murray Community Recovery Hub.

The first stage of considering the future vision of the former school site was to identify the community's aspirations.

Commencing in February 2021, Bushfire Recovery Victoria (BRV) and the Corryong and Upper Murray Community Recovery Committees worked collaboratively to deliver a thorough community consultation process.

The team received an overwhelming 349 responses to a community survey. To complement the survey, five focus groups also ran concurrently.

A community workshop in February 2022 validated the data that emerged from the survey and focus groups.

Consultation activities included:-

- A comprehensive survey to determine community connection

to the historical school building and identify community aspirations for the future of the site

- Focus groups targeting high-interest community cohorts to dive deeper into community aspirations

• A community workshop to test outcomes from the first two consultation activities and ensure analysis outcomes genuinely reflected community sentiment.

In the community survey, youth recreation was categorised under community recreation space, which came through as a clear priority.

Many responses highlighted that there needed to be a space for youth activities like sporting facilities, pump bike track, parks, skate park.

More than 90 per cent of survey respondents indicated that the historic building should be retained, respectfully restored and used for community benefit. When asked what part of the site should be retained, respondents answered:-

- The historically significant building (64%)
- The oval area (44%)
- The buildings along Hanson Street frontage (31%)
- All buildings (28%)

Following presentation of the consultation report from BRV, Towong Council resolved to support further investigation, consultation and business planning into possible future uses of the site and committed to:-

- Securing a tenancy lease for the former Corryong primary school site until 30 June, 2025

• Undertaking a detailed condition assessment of the former Corryong primary school building (heritage building)

• Developing a business case and creating a masterplan for the former Corryong primary school site based on the outcomes of the community consultation report

• Tabling the community consultation report and recommended next steps with the Victorian government via the Department of Education and Training

Council is currently preparing documentation to undertake the condition assessment and business case/master plan.

Further information will be made available as it becomes available.

Details of the process to date including the consultation outcomes report can be found online at <https://ourrecovery.com.au/corryong-primary>.

FREE TICKET WITH EVERY SCHOONER

Joker Poker

**THURSDAY NIGHTS STARTING 2ND JUNE
HAPPY HOUR 5-7PM AND DRAW AT 7:30PM
CORRYONG FNC RAFFLES FROM 6.00PM**

**BOTTOM'S UP @ THE BOTTOM PUB
CORRYONG HOTEL MOTEL
PH: (02) 6076 1004
EMAIL: [INFO@CORRYONGHOTELMOTEL.COM.AU](mailto:info@corryonghotelmotel.com.au)
WEB: [WWW.CORRYONGHOTELMOTEL.COM.AU](http://www.corryonghotelmotel.com.au)**

ADVERTISEMENT

(Small green ballot paper)

You must number every box.
Electoral division of **INDI**.

3	ALEKSOV, Angel
4	HAINES, Helen
5	O'CONNELL, Lachlan
9	WILLIAMS, Stephen
10	STEVENS, Beth
2	GILBERT, Benjamin
8	FISHER, Liz
1	DAVID, Nadia AUSTRALIAN LABOR PARTY
6	FIDGE, Julian
7	LYMAN, Ross

The House of Representatives
Start here and you must number every box.

Authorised by Chris Ford, Australian Labor Party, Victorian Branch, 438 Docklands Drive, Docklands 3008.

Remember... number every box to make your vote count.

Only a Labor Government will deliver for INDI.

VOTE 1

Nadia DAVID

AND LET'S BE PART OF SOMETHING BIGGER



BUSHFIRE RECOVERY BULLETIN

This regular bulletin provides recovery updates following the the 2019–20 Victorian bushfires.

Bushfire Recovery Victoria proudly works in partnership with council and the local community to support bushfire recovery.



BUSHFIRE RECOVERY GRANTS FOR COMMUNITY FACILITIES

Twenty-five Victorian community organisations in bushfire-affected areas will share in more than \$1 million to build, upgrade or repair important local facilities.

The Bushfire Recovery Grants for Community Facilities were established to make community facilities safer, better and more welcoming to everyone.

Previous recipients of Community Facilities grants include:

- \$45,000 to upgrade playgrounds at the Edi Upper Hall and the Whitfield Recreation Reserve
- \$50,000 for an accessible restroom at Wangaratta Kennel and Obedience Dog Club
- \$50,000 for a storage facility for the Rotary Club of Mitchell River
- \$50,000 to build a dedicated bushfire storage facility to house firefighting and fire prevention equipment at Tamboon Inlet
- \$50,000 to purchase a tractor and mower for the Walwa Golf Club

- \$50,000 for playground upgrades at the Tambo Upper Community Hall
- \$50,000 to upgrade to an accessible restroom at the Tintalra Recreation Reserve
- \$49,975 to install an energy system including solar panels and battery storage at the Corryong Historic Machinery Club
- \$49,307 for repair works to the Tallangatta Sports Centre
- \$48,637 for building renovations at the Cudgewa Hall
- \$50,000 for building renovations for the Corryong Opportunity Shop
- \$50,000 for stage two of works on the start of the trail at Big Hill Mountain Bike Park.
- \$50,000 for upgrades to the Myrtleford Community Hall.
- \$50,000 to replace the Mongan's Bridge Caravan park playground.
- \$45,000 to upgrade the kitchen and bathroom facilities at the Lucknow Memorial Hall.

- \$40,017 to upgrade the facilities at the Myrree Hall.
- \$35,024 for the Omeo and District Agricultural and Pastoral Society to upgrade their community meeting facilities.
- \$35,000 to build a skate ramp at Harrierville Recreation Reserve.
- \$33,586 to resurface the netball court at the Lakes Entrance Football and Netball club.
- \$32,000 for the Rotary Club of Bright to replace the fence around their waterslide.

Bushfire Recovery Grants for Community Facilities are still available and close 30 June 2022. Grants up to \$50,000 are available for community groups seeking to build, upgrade, or repair local facilities. We welcome applications for projects that help to bring communities together and support community recovery and resilience.

For more information, eligibility and to apply, please visit vic.gov.au/bushfire-recovery-grants-community-facilities.



BORDER TRUST GRANT PROGRAM – ROUND 2 IS NOW OPEN

Image: Corryong Netball Courts

The second round of the Border Trust Grant Program is now open with grants up to \$50,000 available. Applications close 5pm 1 July 2022.

Applications are invited from not-for-profit, community organisations for projects seeking to support communities in Towong Shire affected by the 2019/2020 Bushfires. If there are particular projects requiring more than \$50,000, Border Trust will consider grants up to \$100,000 (subject to prior discussion and agreement).

Previous Recipients of the Border Trust Program include:

In Round 1, seven projects received funding totalling \$316,880. Covering everything from leadership development to restoration works, received up to \$50,000 each, enabling various programs and works to be carried out in the region over the coming twelve months. Congratulations to all recipients.

Full information and application form available at: bordertrust.org.au/granting.



ABORIGINAL COMMUNITY MITIGATION AND CRISIS MANAGEMENT GRANT RECIPIENTS ANNOUNCED

The Minister for Emergency Services Jaclyn Symes recently announced the recipients of Bushfire Recovery Victoria's Aboriginal Community Mitigation and Crisis Management grants. This grant is now closed.

Six Aboriginal organisations and social enterprises will share in \$2.4 million to help strengthen Aboriginal communities' resilience against natural disasters.

The Aboriginal Community Mitigation and Crisis Management grants will deliver projects that support the critical role Aboriginal organisations play in making sure their communities are prepared for bushfires and support Traditional Owners to share their knowledge of land management and Country.

In the North East, Duduroa Dhargal Aboriginal Corporation received funding to employ Traditional Owners to build existing traditional fire knowledge and undertake work to protect ancestral lands and lessen the impact of future bushfires.

FOCUS PARTNERS

OUR NEXT CORRYONG VISIT WILL BE
Wednesday June 15, 2022

• Tax Returns • Business Advice • Accounting Services
• Financial, Investment & Retirement Planning Advice

Ph: 02 6021 3399

office@focuspartners.com.au

81 Hanson Street, Corryong

FOCUS PARTNERS - OUR FOCUS IS YOUR FUTURE

Fire fighters recognised for service

The NSW Rural Fire Service Riverina Highlands held a National Emergency Medal and Long Service Presentation evening at the Pickled Parrot Providore in Khancoban on Saturday evening which included the official handover of a new tanker to the Bringenbrong brigade.

The National Emergency Medals were presented by Minister for Emergency Services and Resilience, Stephanie Cook, and NSW RFS Deputy Commissioner, Kyle Stewart, to members of the Bringenbrong, Ournie, Maragle and Tooma Brigades.

The Bringenbrong brigade also officially received its new Category 1 Grassland Fire Tanker to add to the Khancoban Township Cat 1 and Cat 7.

The keys to the new truck were presented by the Minister to Captain Adrian Cass and brigade members.

Mr Cass and Bernie Sheather were also presented with Life Memberships of the Bringenbrong Rural Fire Brigade, which were presented by NSW RFS Superintendent, Jon Gregory, Riverina Highlands District.

Mr Cass has been a



Adrian Cass (middle) and Bernie Sheather are presented with the awards by RFS Superintendent, Jon Gregory

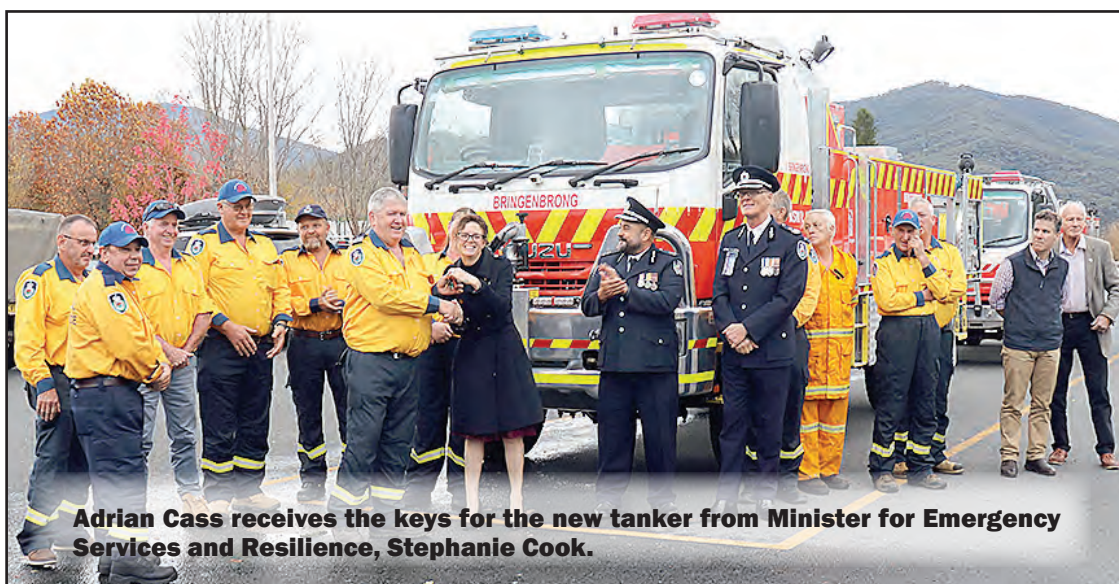

Adrian Cass receives the keys for the new tanker from Minister for Emergency Services and Resilience, Stephanie Cook.

member of the fire brigade for more than 20 years, holding the position of

captain for seven years. Mr Sheather, a member since 1976, is the current

secretary, having held the position for more than 35 years. He has also held

the position of Deputy and Senior Deputy Captain for more than 24 years.

Communities can share in the power

Community-owned energy retailer, Indigo Power, has launched its second crowd-sourced investment offer as they move to the next exciting stage of growth.

The share offer will be the first time community members have the chance to buy shares in the company after the first offer, in May 2020, sold out in under three days.

The company is now seeking expressions of interest from potential investors, prior to the completion of the share offer in June.

Indigo Power was named one of Australia's greenest electricity providers in Greenpeace Australia's green energy guide and funds used from the share offer will be used to invest in a marketing program able to reach new customers.

A successful share offer will allow the company to pursue clean energy projects across North East Victoria and Southern New South Wales.

Feasibility studies are currently underway for a pumped hydro facility in the Upper Murray and on the replication of the Yackandandah community battery in towns across the



Indigo Power commissioned Yack01, Australia's first community owned battery in Yackandandah.

Photo: Georgie James

region.

Indigo Power will also soon begin supplying clean energy to electric vehicle drivers, with the first Indigo Power-operated EV charging station.

Indigo Power Managing Director, Ben McGowan, said it was great to be able to come back to the community with the share offer after many missed out in 2020.

"This share offer was always a part of our long

term plans but we know that many people have been waiting for a long time for the opportunity," he said.

"We have made significant progress, thanks to our first 280 shareholders. We've launched our energy sharing software, our flagship power storage project, the 'Yack01' community-scale battery, is now supplying

electricity every evening to our customers in the Yackandandah Community Energy Hub and, with our community partners, we're currently delivering innovative projects that build energy resilience into bushfire affected communities

"We will use the funds raised through the offer to drive renewable energy-focused projects around the region and to

continue to improve our electricity retail offer," Mr McGowan said.

We are full of optimism for the future."

The investment offer is being run via the crowd investment platform Birchal and Indigo Power is now accepting expressions of interest from potential investors via the platform up until June 6, 2022.

Lester & Son Funeral Directors

A tradition of personal, professional care since 1907



Cherie Wright Tony Egan John Vogel

02 6056 1700

49 Thomas Mitchell Drive Wodonga

Advertising pays dividends

Corryong Courier

Phone: 02 6076 1045

adverts@corryongcourier.com.au

editorial@corryongcourier.com.au

Towong race tales wanted for new book

Do you have racing blood in your veins? Do the tales from your parents and grandparents' past resonate with stories of past glories on the Towong racecourse?

If so, perhaps you could share your gems with two writers who are hoping to publish a book about the Towong Turf Club.

Honor Auchinleck and Dixie Coutts are

compiling a history of racing at Towong since the turf club's very early days through to the present.

They are hoping to publish a book featuring stories about the club, horses and the people integral to the development of the club. The pair intend to include many photographs and anecdotal evidence highlighting important events and

features throughout the club's colourful history.

Their research has already yielded some fascinating stories.

For instance, Glenloth, winner of the Towong Handicap in 1891, whose owner fell on hard times and sold him to a Melbourne milkman, who subsequently entered him in the Melbourne Cup and won it!

How many people know that a locally owned horse which won the Towong Cup a record three times was named Tom Bourke, after a famous boxer in the early part of the 20th century because he was such an outlaw?

There is also authentic evidence from local historian, John Whitehead, who remembers the tree in the school yard at Towong which was used to mark the end of the very early races along the side of the road between Corryong and Towong before the present racecourse was laid out in 1923.

This tree was named Black Mag's Tree (pictured) and John has supplied photographs which attest to its historical significance. A plaque at the site marks the

125th anniversary of the establishment of the Shire of Towong, which was unveiled by indigenous elder, Eddie Kneebone, in 1999.

In 1882 the first Hume Plate was won by John Whitehead's grandfather's horse, Wabba. Sadly, this speedy galloper was burnt to death in a stable fire the following year.

More recently, in 1970, the president of the Towong Turf Club, Tom Waters, reported that the club had enjoyed a very successful year with a capacity field of 12 horses in the Cup. He added that Towong had been granted an extra day for the following year, making five meetings. This was something of a coup, because of 28 extra days applied for in Victoria, only five were granted.

Now there is a rule that no more than 10 horses can make up a field at Towong and the committee fought tooth and nail to retain just two meetings until the second one was axed several years ago.

"What a shame it is that small country race clubs like Towong are no longer encouraged to conduct multiple meetings

a year, when they are such popular and important community events," Dixie observed.

Many people still remember the hugely successful Centenary Gold Cup meeting of 1971, when a crowd of more than 2,500 cheered on the local horse, Moab, to win the Cup. The course was swarming with visiting dignitaries and at least one Rolls Royce was sighted in the car park!

Later that night the Tooma Hall rocked with 600 dancers at the Aftermath Ball. The entrance fee was "seven bucks a stallion and fillies free agistment".

Stories such as these are what brings a book to life and Honor and Dixie are keen to include as many such poignant, interesting and humorous details from the past as possible.

They are inviting

anyone with a story or old photos which may shed light on some aspect of racing at Towong to share these with them in the interests of producing a genuine history of the Towong Turf Club.

Readers may have noticed that there are Towong Turf Club commemorative tea towels on sale around Corryong - you can buy one for \$20 and help bring the history book to print.



Fire fighters celebrated

North East firefighters are among the thousands of volunteers being celebrated as part of National Volunteer Week.

Chiltern Fire Brigade's Kurt Sorensen has been a CFA volunteer since he was 11 years old and said volunteering is part of his family.

"My father's the vice-president at the local football club and my mother runs the canteen, plus my brothers and partner play footy and netball there as well," he said.

Mr Sorensen's volunteering with CFA extends beyond the brigade, with the young member also stepping up to be part of the District 24 Youth Reference Group, and the State Youth Reference Group.

"They both work in slightly different ways as the local group is about getting young members together and sharing the experiences and ideas from their group, then

feeding that into the local Assistant Chief Fire Officer (ACFO).

"In the state team though, we receive a topic each week then we come together and identify what we can be doing better from a youth perspective, before advising the CFA Chief Officer and CEO which helps them make decisions."

CFA Chief Officer, Jason Heffernan, said National Volunteer Week is Australia's largest annual celebration of volunteering which gives us the chance to recognise the vital work of our volunteers.

"Our members selflessly provide assistance to community members across the state, taking time away from their families, friends and workplaces, to help others," he said.

"As a former volunteer firefighter myself, I know that volunteering can be an incredibly rewarding experience.

"Our volunteers come

from all walks of life; they are tradies, lawyers, nurses, chefs and farmers - just to name a few.

"The diversity of skills and expertise our volunteers bring to their CFA roles further boosts their brigades and the organisation, for which we are very grateful."

CFA Chief Executive Officer, Natalie MacDonald, said this week and every week we thank our dedicated volunteers for the incredible contributions towards keeping Victorians safe.

"I am continuously impressed by the ongoing hard-work and professionalism of our volunteers," CEO MacDonald said.

"They sacrifice their personal time to protect and serve Victorians and they are leaders and educators in their communities."

Find out more at <https://www.cfa.vic.gov.au/volunteer-careers/> volunteers

Light shines on local volunteers

Hard working volunteers across north east Victoria including a Corryong organisation, have been recognised for their outstanding contribution to the community during National Volunteer Week (May 16-22) which celebrates and recognises the vital work of volunteers.

Across Victoria, 1500 Crown land reserves are managed by more than 1200 committees of management with the support from the Department of Environment, Land, Water and Planning (DELWP)

Types of reserves include public halls,

recreation reserves, rail trails, coastal reserves, caravan parks and nature conservation reserves.

Locally, three members of the Corryong Youth Club Hall Committee - Lorraine Griffiths, Karen Paton and Ros McKenzie - were recognised for their outstanding contribution over many years.

Hume Regional Director, Clare Kiely, said "Some of our region's most loved spots are managed by volunteers, putting in their time and energy to look after areas of important biodiversity and recreational value for local communities.

"A big thanks goes to everybody involved

in committees of management. Whether it's your first time on a committee, or you've been a member for many years, DELWP and the community greatly values your skills, experience,

knowledge and the time you devote to being a committee member. "We're thrilled to acknowledge these groups for the work they do to preserve and our state's precious natural assets."



The Lions hall is used for many community events including the Australia Day breakfast.

TANIA MAXWELL MP

Derryn Hinch's Justice Party

MEMBER FOR NORTHERN VICTORIA

Working for fair, just, safe communities.

taniamaxwell.com.au 03 4700 1787

tania.maxwell@parliament.vic.gov.au

PO Box 994 Wangaratta VIC 3676

taniamaxwellmp

WHAT'S ON @ THE BOTTOM

CORRYONG HOTEL MOTEL

Wednesday 25/5-TRIVIA-6.30PM

-SHOW RAFFLES-6.30PM

Saturday 28/5-TRACEE JAMES-8.30PM-LATE

Wednesday 1/6-TRIVIA-6.30PM

-SHOW RAFFLES-6.30PM

Thursday 2/6-HAPPY HOUR-5PM-7PM

-CORRYONG FNC-RAFFLES-6PM

-JOKER POKER-DRAW AT 7.30PM

Friday 10/6-INTENSITY- 8.30PM-LATE

SEE YOU @ THE BOTTOM

Snowy drives safety message home

Snowy Hydro is committed to ensuring the next generation of locals are equipped with the skills and knowledge to help keep them safe on the roads, with the long-running Young Driver Program playing a crucial role.

For four years Snowy Hydro has partnered with Driving Solutions to provide local students with young driver training. This month more than 275 local young people participated in the program, which helps prepare Learner and Provisional drivers for the driving conditions they face on Snowy Mountains roads.

Since its inception in 2002, the Snowy Hydro Young Driver Program has provided more than 1,600 local students with the opportunity to improve their driving skills and become safer drivers.

Snowy Hydro CEO and Managing Director, Paul Broad, said the program demonstrated Snowy Hydro's continued commitment to the safety and well-being of young people living in the Snowy Mountains region.

"The Snowy Hydro Young Driver Program

delivers learning exercises and activities that give our local kids the skills and knowledge to help keep them safe on our unique and at times, challenging, mountain roads," Mr Broad said.

"These young and inexperienced drivers gain so much from the program - it's really valuable and we at Snowy Hydro are proud to play a part in ensuring greater safety on the roads where we live and work."

The program covered topics such as correct seating position and the importance of understanding the difference between vehicles with anti-lock brake systems (ABS) and vehicles without ABS.

Students were taught when to fit snow chains on their vehicles while travelling in snow and ice conditions. They were also shown the correct way to use and fit snow chains on a vehicle.

The activities and exercises provided useful and practical knowledge to assist the students when behind the wheel. Topics included driver attitudes and the effects of distractions when driving

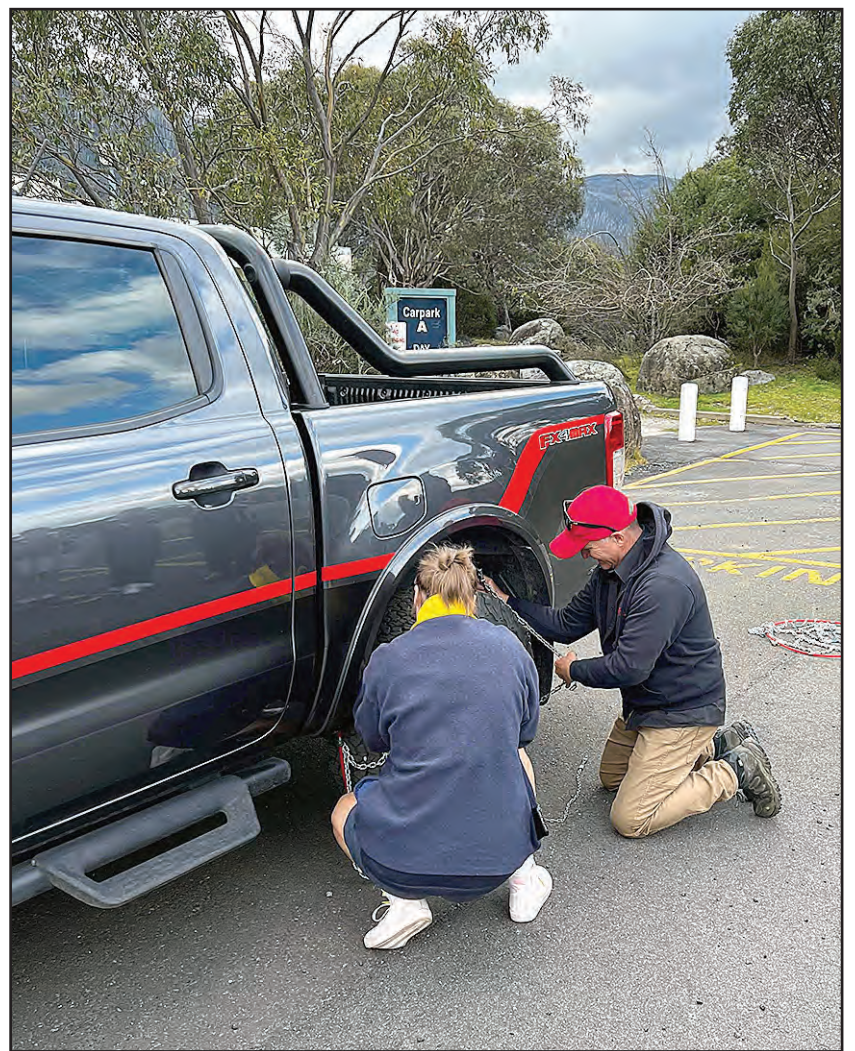

Local students learn how to fit snow chains.

such as mobile phones, passengers and vehicle navigation.

Other practical skills were also discussed including how to

understand correct and incorrect tyre pressure on their vehicles.

Corryong Footwear

Shop 1, Man From Snowy River Arcade
21 Hanson Street, Corryong. Ph: 02 6076 1277

RETIREMENT SALE NOW ON!

All children's runners, school shoes etc. now \$20 a pair

Plus other great specials!

First in for best choice!

The place for your family's footwear

BACASH'S EMPORIUM

We stock a great range of Clothing, Fabrics, Bedding & Towels
Find a treasure in Bacash's Attic

OPENING HOURS

Monday 9am to 4pm

Tuesday 9am to 4pm

Wednesday..... CLOSED

Thursday 9am to 4pm

Friday 9am to 4pm

Saturday 9.30am to 1pm

23 Hanson St. (in the heart of Corryong)

Dolly brings brighter beginnings for kids

Snowy Valleys Council (SVC) has launched an innovative book gifting project for children born in the area.

Every newborn child living in the Snowy Valleys area will be eligible to access Dolly Parton's Imagination Library, which will see them receive a free age-appropriate book every month, until they turn five.

SVC Councillor, Julia Ham, who has a special interest in early childhood education, said she was delighted to see a program like this rolled out in the Snowy Valleys community.

"This is a game changer for the young children in Snowy Valleys," she said.

"This is such a practical

approach to better equip our young children and to provide the resources to connect parents and children through a love of reading.

"To have access to new books each month is really starting a world of literary imagination. Just brilliant!"

Early childhood census data shows children in the Snowy Valleys are below the state average when it comes to literacy and communication skill levels.

The aim of Dolly Parton's Imagination Library is for all children to have access to their own library of literary resources from an early age which will assist them in developing the essential

emerging literacy skills they will rely on when learning to read and write.

The highly respected charity organisation United Way Australia will work with council and administer the Snowy Valleys project. United Way Australia works towards improving lives and strengthening communities, through its many successful programs.

United Way Australia's CEO, Clayton Noble said "We are very excited to be partnering with the Snowy Valleys Council on this innovative program.

"The commitment to ensuring every child born in the region is 'school ready' is to be applauded. Dolly Parton's

Imagination Library will be a big boost to achieving this goal."

"This is a project which deserves widespread support from across the community because it will deliver positive outcomes at individual, family and community levels," said Cr Ham.

"I encourage families with newborns to sign their children up to the program."

Initiated by Dolly Parton over 20-years ago, Dolly Parton's Imagination Library has seen more than 160 million books delivered to children in the USA, Canada, the United

Kingdom and Australia.

Dolly Parton's Imagination Library mails free age-appropriate and culturally sensitive books to children registered in the program from birth to the age of five.

For more information about Dolly Parton's Imagination Library and for further enquiries chat with staff from your local library or contact the council's Library C-ordinator on (02) 6941 2541 or email info@svc.nsw.gov.au.

New parents can also speak with their local family health nurse.



Local mum Bonnie with her children, Maggie and baby Charlie, at the Tumut Library. Charlie is enrolled in the Dolly Parton Imagination Library program.

Corryong Neighbourhood Centre

Position Vacant - Upper Murray Community Bakery is seeking bakers. If you are qualified or wanting to start your baking career, contact Sara at the CNC.

Upper Murray Employment Group - Join the Facebook group to advertise or find employment
Good Shepherd NILS - No interest loans for Centrelink recipients - Contact Nikki 0429 024 717
Knit & Natter - Most Tuesdays - 1.30pm - Anglican Hall - Gold coin donation - Phone 0448 350 320
Hume Riverina Community Legal - Free legal advice - Visiting fortnightly - Call 1800 918 377
Wodonga Eyecare - Visiting Monday Fortnightly - Phone 02 6056 4000
Screen Printing Workshop: 25th May - 3.30pm - Bring an item of clothing & a design idea. All ages welcome, under 12's requires parental supervision.
Youth Space - Open after school - All 12-24-year-olds welcome - WIFI, Nintendo switch, PlayStation, boardgames and more to enjoy!

THANK YOU FOR SUPPORTING THE CNC SOCIAL ENTERPRISES

Upper Murray Community Bakery - Open 7 days a week - Phone 02 6076 1196
Upper Murray Community Garage - Open Tuesday - Thursday - Phone 02 6037 1587

FOR THE SAFETY OF OUR STAFF & CUSTOMERS, PLEASE CHECK IN, USE HAND SANITISER ON ARRIVAL AND MAINTAIN SOCIAL DISTANCING REQUIREMENTS

CNC 39 Hanson St, Corryong Vic 3707 ABN 38 793 076 812
Ph: 02 6076 2176 Email: admin@corryongnc.org

John Hossack
FUNERAL SERVICES
Always caring



The ultimate funeral care for your loved one

Ph: 02 6041 3855 • 435 Wilson St, Albury
www.hossackfunerals.com.au



Advertising Pays Dividends

Corryong Courier
adverts@corryongcourier.com.au

Upper Murray Sport

More news from around the clubs

New courts are blooming

Cudgewa notes
continued from page 12:
Under 14s: We had a great day beating Bullioh by 10 goals. There was a bit of doubt as to how competitive we could be leading in to the match as we were missing six of our regular ball winners.

However, that was soon forgotten with a fantastic first quarter in what was a great all round team performance. Everyone stepped up to the challenge and confidence grew as each minute passed.

Our backline was solid and kept rebounding us into attack and setting up Hayden Mongan with four goals, backed up by Sachin Samwells (3) and Moose Bloom (2).

Derby Whitehead played well in the centre along with Isaac Nicholas and Jack Jarvis in defence.

U11s: The team was awesome with everyone putting the systems that we had been practicing at training into action. The shepherding and passing enabled a great win against a hard tackling Bullioh.

Best: Monty Whiteley, Ryder Pearce, Jodie Pearce, McKinley Klippel, Declan Faithful and Pip Faithful.

Netball: A Grade: The girls really came together with some players having their first game for the season.

The attack worked well adjusting to the new combinations quickly throughout the day. our defence worked tirelessly against a strong shooting combination with Megan Nankervis playing it hard to slow down the opposition's ball movement. Awards - Kirby Hillier and Sarah Dart with the players' player votes going to Soph Greenhill.

B Grade: Bullioh put up a strong fight this week but our circle defence



A for Effort:-
It was a goal to the Roos despite the desperate measures of two Swans' defenders.

of Julianne Reiners and Georgia Nicholas was unstoppable. Assisting with the circle defence was the defensive pressure down the court, which was fantastic to watch. The attackers had an outstanding week, adjusting well to whatever Bullioh threw at them.

Awards - Lizzy Star and Lil Fair with the player's players' votes going to Julianne Reiners.

C grade: Bullioh was strong but it was great to see our girls gelling together to put up a solid fight. Defence down the court from Shannen Collins and Chantal Dodd was outstanding and kept the pressure on their attack all day. Awards - Tash Tregilgas and Brooke Tregilgas (shooters) with the players' votes going to Eden Cook in defence.

D Grade: We had a pretty tough game this week as Bullioh's side was pretty rough. Our defence was amazing with Chloe Land, Jasmine Cane and Ruby-Jean Klippel pumping the intercepts out together! Best - Jasmine

Cane, Ruby-Jean Klippel, Thailia Whitehead.

U15s: We had some helping hands from some boys, so thank you Jack Jarvis, Sachin Samwells and Blake Dakin for helping us out as we were a bit short. There were a few changes made throughout the game but that didn't stop them from playing hard. It was pretty even the whole of the game and we ended up only losing by one goal. Awards - Gemma McNamara & Ruby-Jean Klippel

U11s: Our little under 11s team had a pretty tough game on the weekend as Bullioh's girls were pretty tall. Although being defeated, they held their heads high and worked extremely hard to get that ball in their hands. Awards - Pippa Faithful & Alana Wheeler.



Swans Nest

Football: Reserves: Things are really starting to come together for the resses with four different

goal kickers and every player contributing to what was a pretty good game to watch. Awards: \$30 - George Webb Rose, \$20 - Ty Luton, \$20 Rebel Voucher - Braydon Crighton, Club cap - Riley Milgate.

Seniors: We started with a few more new quality recruits and jumped out of the blocks to be only behind by two points at the first break. We continued to fight out the game with new comers Ivan Rogers and Ewan Hampton in most passages of play. Mitch Pieper and Mitch McLean had great games and Jack Miller snuck in with four goals.

Tumba ran away with the game a bit in the last quarter but we were extremely competitive all day and we will only get better as we get to know each other's game and get a bit more match fit.

Awards: Mug - Jack Miller, \$50 - Ivan Rogers, \$20 - Mitch Pieper, Club cap & stubby holder - Mitch McLean, \$20 & FFNC singlet - Ewan Hampton.

Things are growing at the Cudgewa tennis courts.

The club recently received a donation of a Mountainous Peace Lily to continue the upgrades to the courts.

The striking artwork (pictured) was created and donated by Steven Bergamin of Steve and Rita's Junkyard Art at Numurkah and would not have happened without the assistance of local, Deborah McNamara.

The artwork was cleverly made out of the lights from the old courts, beautifully incorporating the old with the new.

"We think it looks fabulous and cannot thank



Steve enough for this beautiful addition to our courts and town," said club official, Tony Jarvis.



High Country Darts



Results R3: Possum Pointers d Bottoms Up 5-2; Bottom Pub d Biggara 5-2; Brumbies d Tinpot 4-3.

Ladder
Bottom Pub ..12 200.0%
P/Pointers8 200.0%
Brumbies8 75.0%
Tinpot4 133.3%

Biggara4 50.0%
Bottoms Up0 50.0%
Sharpshooters
Highest peg: M Russell 60; Men's highest score: Paul Cox 140; Ladies' highest score: Andrea Carmody 112.
Draw: **R4 24/5/22**
Biggara * v Poss. Pointers

Brumbies v Bottom Pub
Bottoms Up v Tinpot
* Note: Biggara home games are now played at the Bottom Pub.

TEE TO GREEN

Welaregang

On another perfect day for golf, Tony Jarvis and Ken Lebner had a slow start with 13 and 15 points respectively on the outward nine but then Kenny lifted his game to new heights, coming home with a great inward nine, posting 21 points, to record his first win of the new season.

The ever-consistent Tony had to again settle for second with 32 points, his third in a row. Veteran Bill Sheather was again in the mix with 29 points. Ken will be happy to know his score was noted by the handicapper and he now has a new number to play to.

The club is looking forward to hosting the annual Legacy Day this

Sunday. This is a 3-person ambrose and is always a great day while raising money for the Legacy group. Contact Lance Noonan, 0419 927 470 with your teams.

Corryong

Mon. 16/5
(Stableford):-

The winner with 10 points Maree Irving from Sylvia Montgomery on countback from Sue Morley and Cheryl Smedley and the lucky ball went to Maree.

Coming up

Hills Zone Open Tournaments:- Adelong May 29th, Welaregang August 28th, Batlow September 25th,

Other events:- Adelong Tax Buster July 10th; Batlow 1000 November 12th.

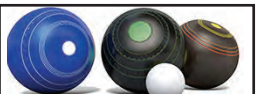

Corryong Indoor Bowls

Results R2
CNC d Bandits 17-8; Thougla d Lucyvale 17-7; Pole Cats d St George 21-11; Bacashes d Hoppers 17-9; Attackers d Indiettes 19-8; Courthouse forfeited to AFL.

Ladder

Thougla 8 +23
Attackers 8 +23
Bacashes 8 +17
Courthouse 8 +9
Pole Cats 4 +15
CNC 4 +13
Indiettes 4 +9
Bandits 4 +8
Lucyvale 0 +7
Hoppers 0 -10
St George 0 -20
AFL 0 0
Draw R3 23/5/22
AFL v Hoppers (6)
C/house v Pole Cats (5)
Bacashes v Attackers (1)
St George v Lucyvale (2)
Indiettes v Bandits (4)
Thougla v CNC (3)

ALL THINGS RURAL

...That's what we do better!

Bale Up Hayfeeder
380425

- Made in Australia from Australian steel
- Easily transported

Waste Not Oval Hay Feeder
392850

- No loss of feed into the pasture or pasture damage
- Less machinery required and labour
- No wastage saves hay and money.

Arrow AFQ30 ProYard System*
254512

- Easy and efficient to use
- Easy to use vet crush which is quiet and has dual locks for added strength
- 10yr guarantee.

*Terms and conditions apply.

Norton Cattle Loading Ramp Adjustable
911930

- 50mm treated pine flooring for quieter loading
- 65 x 65mm SHS main frame
- 5 adjustable height positions from truck to trailer height
- All galvanised steel used.

Jacky® Side Discharge Bin
223402

- For bagging feed, feeding out grain & pellets, filling seed drills & self-feeders & dispensing into product blending systems
- Sloped with large discharge opening for positive drainage & minimal retention in hopper.

989 Murray Valley Hwy, Corryong Ph: 02 6076 1288 Open: Mon - Fri 8am - 5pm Sat 9am-12pm agwarehouse.com.au

PUBLIC NOTICES

FINAL GARAGE SALE

Est. Fred Werrett

100 Harris St.,
Corryong

Saturday June 4, 2022

9am - 12 noon

Inc. quality tools, workshop equipment, household items, electrical appliances and more!

***BORDER AUTO GLASS**

IN CORRYONG

Thursday May 26

At Mildren & Coysh
12-16 Towong Road

For an appointment
phone 6076 1151

LEARN TO DANCE

Thursdays 7 pm-9 pm

Corryong RSL Hall

Runs until June 7th

Call or message Kerry
on 0428 769 101 to

book your spot.

No cost

(Towong Shire Bushfire
Recovery Grant project)

CHIROPRACTOR IN CORRYONG

Dr Rowan Daniel

Visiting weekly

on Fridays

9.30am-5.30pm

Next appointments:

May 27th, 2022

81B Hanson St., Corryong

Ph: 6056 2185

CORRYONG TAXI SERVICE

Servicing

Corryong

& District

0418 697 807

Ken Bailey Mechanical Repairs

46 Donaldson St

Corryong

Ph: 6076 1119

PERSONAL NOTICES

LOVE IS CLOSER THAN YOU THINK

There is no need to travel to the ends of the earth to find the one you love.

Our matchmakers know so many sincere and genuine singles who are in your area and wanting to meet right now.

You don't need a computer, all you need is a phone and the successful matchmakers will put you in touch as soon as today.

Ph 1300 856 640
or txt 'local' to 0450 345 300
www.successnetwork.com.au

FOR SALE



Caravan - 2007 Crusader Dream Haven, good cond., well maintained, reg. R73 584, 5 months left, \$33,000. Ph: 0438 249 561.

Courier Classies

02 6076 1045

HAY CONTRACTING

HAY CARTAGE

- All areas (Experienced contractor / own truck)
 - Can also supply grass hay & cereal hay (big rounds)
 - Competitive rates
- Contact: Rod Cowie
Corryong
0408 364 910

POSITIONS VACANT



Are you keen to get outdoors and see the countryside?

Do you work well in a small team and enjoy meeting new people every day?

Do you have a hidden love for aviation and think working in the industry could be an exciting change?

Do you pride yourself on customer service and getting the job done right every time?

If these sounds like you, keep reading!

We are seeking a Ground Support Crew member to join our close knit team.

Working in the agricultural aviation sector, our primary work is agriculture from helicopters. However, you will get to experience other types of aerial work operations, including firefighting, lifting work and power line patrols.

This job requires:-

- Someone who is physically fit, it is fast paced work and does involve some heavy lifting.

- Someone who is mentally fit and keen to learn new skills.

- Someone who is able to travel away from home for up to a week – ten days at a time (we cover a large area between NSW and Victoria and are always at the mercy of the weather gods).

- Someone who likes being outside and is happy to engage with farmers and customers daily.

- Someone who has some agricultural background or knowledge is always a great start.

- Someone who has basic mechanical knowledge and respect for the equipment.

If you are this person, we would love to hear from you. This role is a great foot in the door into the world of aviation and agriculture and there is the option for growth paths within the business for the right person.

Email a cover letter and CV to our Ground Operations Director, Ken Gorman, at ken@rotorsolutions.com.au.

LOOKING FOR WORKERS?

Advertise in the
Employment section of the
Corryong Courier
Ph: 02 6076 1045
adverts@corryongcourier.com.au

POSITIONS VACANT



Employment Opportunities

Please check our website for current employment opportunities: www.corryonghealth.org.au/employment

"Corryong Health is an Equal Opportunity Employer; we encourage applications from Indigenous Australians, people with disabilities, young people and people from culturally diverse backgrounds"

Caring for the Upper Murray

Together, strengthening the health of our community

Project Manager, Upper Murray Local Development Strategy

The Upper Murray community is seeking to rethink its economic future and plan for diverse, sustainable and innovative activity in established and new industries. This follows a number of changes to its economy and population including changes to the agriculture, forestry and tourism sectors, the impact of drought and more recently bushfire and COVID-19, demographic changes and growth in sectors such as healthcare and social assistance.

To investigate the options for the future of the economy, Upper Murray Inc. (UMI) is seeking to employ a Project Manager who will identify local assets and potential areas of strength for future development. The Project Manager will assist the community in developing those areas of strength into proposals for development and investment.

The position will be supported by the project partners Upper Murray Inc.; Towong Shire Council; Snowy Valleys Shire Council; Tumbarumba Chamber of Commerce; Upper Murray Community Recovery Committees; Corryong Community Neighbourhood Centre; and the Victorian Government Department of Jobs, Precincts and Regions.

The incumbent will require a good understanding of the Upper Murray, North-East Victoria, Snowy Mountains and Riverina region and proven experience in collaboration, building relationships and project management preferably in an economic development setting. A relevant tertiary qualification or extensive experience is preferred.

To obtain a copy of the position description please email uppermurray2030vision@gmail.com.

Applications close at 5:00pm on Friday June 3, 2022.

Position Title: Project Manager - Upper Murray Local Development Strategy

Term: 12 – 18 months

Salary Range: \$100,000 – \$110,000

Hours: 32 hours per week, starting date July.

Reports to: Upper Murray Inc Board

Work location: Corryong

Advertising pays dividends

Corryong Courier

Phone: 02 6076 1045

adverts@corryongcourier.com.au

editorial@corryongcourier.com.au

Local dog training provides a time out



Gary White watches a working dog going through its paces.

Two one-day working dog training schools with renowned NSW sheepdog trainer, Gary White, were held at Walwa and Towong last week where up to 12 owners and their dogs had the opportunity to take part in the one-day training courses.

The working dog training schools were sponsored and supported by Gateway Health, Red Cross and Towong Shire Council.

'Let's Talk - Working Dogs' training schools are a Red Cross initiative with Gary White that has previously been run in drought impacted rural areas in NSW.

To support some of the smaller bushfire impacted communities in Towong Shire and help re-establish social connections and to provide 'time-out' from rebuilding etc, two free training days were organised.

The sessions included mustering, droving, drafting, backlining and much more. Interest was high with around 40 people attending the Walwa session and more than 20 people were at Towong.

Letters to the editor:-



Caught out by rego error

On Mother's Day, we drove to Tumbarumba for lunch and some shopping and on our way home we were pulled over by a Highway patrol car from Wagga.

We had no idea what it was about. He proceeded to tell us our registration had been out of date for the past 14 months!

We got home thanks to him and did some research only to find our payment had - as Service NSW put it - gone into 'limbo'!

We had actually done everything correctly but Motor Registry had stuffed up, causing us to be driving an unregistered car for more than a year!

If we had been involved in an accident during that time we were not covered by third party insurance or our own insurance.

No apologies, no sorry for getting you into trouble with the police. Just, okay we have fixed it.

I hope no one else has been in this situation!

Jane Wilson,
Corryong.

Where to cast your vote

People who intend to vote in the Federal election in person this Saturday can do so at the following local polling stations

• Corryong - Corryong & District Memorial Hall, Hanson Street

• Cudgewa - Cudgewa Mechanics Hall, Main Street

• Walwa - Walwa Memorial Hall, Main Street

• Tallangatta - Tallangatta Memorial Hall, Towong Street

Polling centres are open from 9am to 6pm.

kids' puzzles



PUZZLES AND PAGINATION ©
pagemasters
Pagemasters | pagemasters.com

Dot to dot

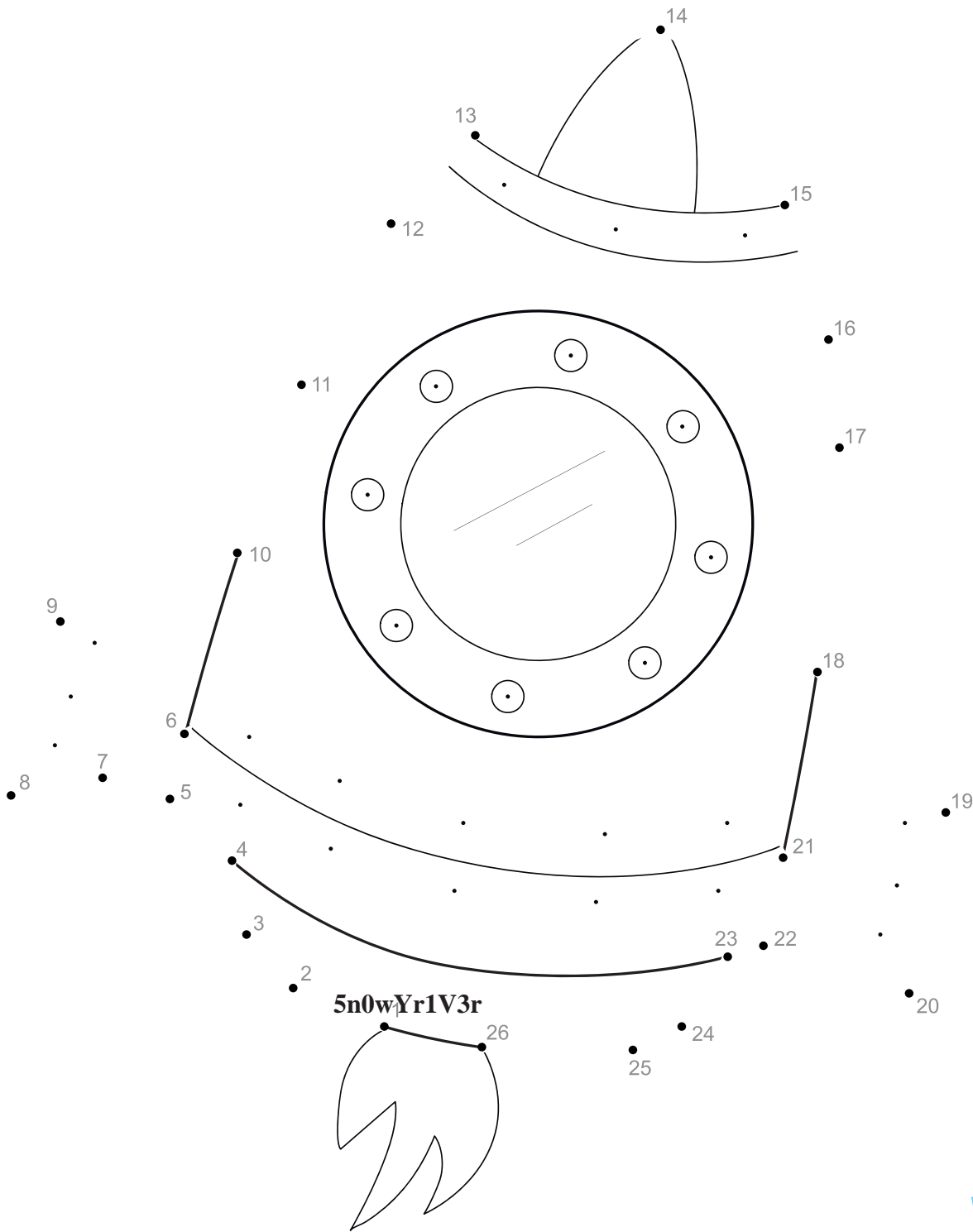

Word find

Can you find all of the words listed?
The leftover letters will spell out a message.

O	W	A	R	M	N	S	U	L	I	N
N	G	A	E	H	A	U	A	C	P	L
O	B	I	K	M	S	G	G	O	A	B
M	J	A	U	I	A	I	R	O	U	S
I	A	R	W	N	Z	T	N	S	H	Y
K	A	S	U	A	U	A	H	A	O	S
I	A	B	A	G	G	I	S	J	P	T
S	O	T	U	M	D	U	I	H	A	S
N	E	E	A	O	U	M	K	N	I	O
G	S	F	W	N	B	N	T	O	A	R
E	R	I	O	O	A	O	E	R	T	S

- NOBUNAGA
- OBI
- PORTUGUESE
- SAMURAI
- SHOGUN
- SPANISH
- TANTO
- TOKUGAWA
- WAKIZASHI
- YOJIMBO

- BUSHIDO
- GETA
- KATANA

- KIMONO
- MASAMUNE
- MEIJI

Secret message: A ruling class of warriors

Spot the difference

Can you find five differences between these images?

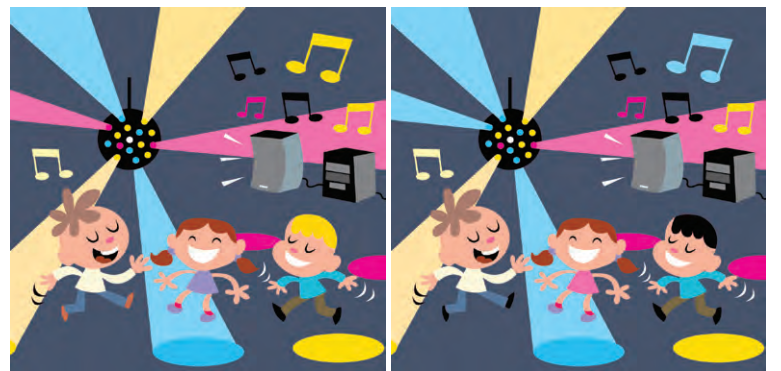

ANSWERS: 1. Left disco beam 2. Left boy's hair 3. Girl's dress 4. Right boy's hair 5. Music note

Junior crossword

Solve all the clues and an eight-letter word will be spelled out.

- | | |
|-------------------|--------------|
| 1 Confess | 5 Afterwards |
| 2 King's headwear | 6 — jet |
| 3 Cabs | 7 Heartbeat |
| 4 Paddock border | 8 Depart |

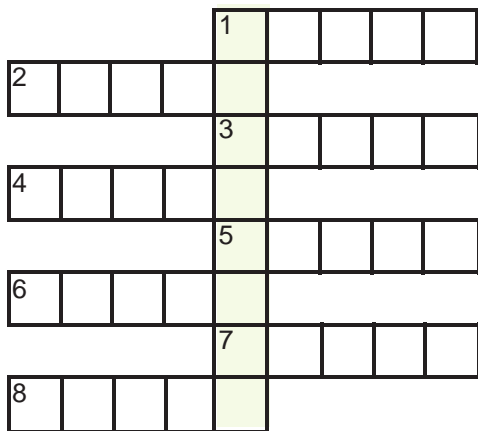

ANSWERS: Admit, Crown, Taxis, Fence, Later, Jumbo, Pulse, Leave, (ANTELOPE)

Quiz

- | | |
|---|--|
| 1 The planet Mars has how many moons? | 7 Is a bat a reptile or a mammal? |
| 2 What kind of clothing is a bowler? | 8 What continent are armadillos found on? |
| 3 True or false: the elm tree is native to Australia? | 9 What year did the last space shuttle (pictured) flight take place? |
| 4 In what country is the Leaning Tower of Pisa? | 10 Diamonds are a form of what element? |
| 5 What animal class does the snail belong to? | |
| 6 Where on the human body is the cuticle? | |



ANSWERS: 1. Two 2. Hat 3. False 4. Italy 5. Mollusc 6. Fingernail 7. Mammal 8. South America 9. 2011 10. Carbon



plus LIQUOR

24-30 Hanson St.,
Corryong.
Ph: 6076 1286

Birthday Club

Maisy Moscrop, May 21, 2011 (11)
Jeht Richards, May 24, 2011 (11)

To register your child in the Birthday Club phone 6076 1045 or emailadverts@corryongcourier.com.au



EACH BIRTHDAY CLUB MEMBER RECEIVES A BIRTHDAY CARD AND FREE PATTIES PARTY PACK

Advertising that pays dividends

Corryong Courier

Online advertising also available

Ph: 02 6076 1045 / E: adverts@corryongcourier.com.au

Services & Business Directory

BEAUTY AND HEALTH

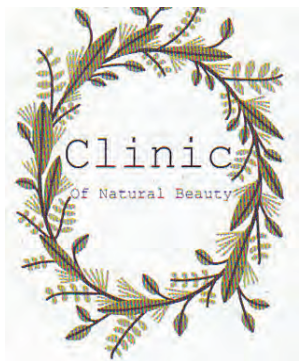

Appointment by phone
 Phone Jane Mongan
 0427 737 556

BUS SERVICE



CORRYONG BUS & FREIGHT

TIMETABLE

Daily service to Albury-Wodonga via Walwa
 Monday to Friday

Departs:

Corryong Newsagency (6076 1381).....	7.30am
Cudgewa.....	7.45am
Tintaldr.....	8.00am
Walwa Store (6037 1291).....	8.20am
Jingellic Store (6037 1320).....	8.45am
Mount Alfred.....	9.00am
Granya.....	9.30am

Arrives:

Snow White Depot.....	10.15am
(474 David St., Albury)	
Wodonga Post Office.....	10.30am
(High St., Wodonga)	

Departs:

Wodonga Post Office.....	1.30pm
Snow White Depot.....	2.00pm
(6021 4368)	

Arrives:

Granya.....	2.50pm
Mount Alfred.....	3.25pm
Jingellic.....	3.35pm
Walwa.....	3.45pm
Tintaldr.....	4.00pm
Towong.....	4.10pm
Corryong Newsagency.....	4.30pm

• Pickup/drop off service available to railway stations, airport and hospitals.

Enquiries: 0427 240 077

• Bus service does not operate on weekends or Victorian public holidays.

CARPET CLEANING

WILESMITH CARPET & UPHOLSTERY CLEANING

Free hallways and mats with house lots
 Pensioner discounts available

Craig & Tanya Wilesmith

Our service and quality are guaranteed



PHONE:
 0428 482 976
 or contact local agent
 Hobie's
 Sports Store
 6076 1121

COMPUTER SERVICES



For competitive prices and local services, systems (on site installation), software accessories and system maintenance. Call to discuss your requirements or for an obligation free quote.

Warwick Ross

Ph: 6076 2233 / Fax: 6076 1609

CONCRETERS

HARRY'S CONCRETING

For a Quality Finish

- Shed Slabs • Pathways
- Driveways • Patios
- Exposed Stamp & Stencil

Bobcat & Tipper Hire

0439 400 418

EARTHMOVING & EXCAVATION

S & K WHITEHEAD EARTHMOVING P/L

- 3 x 20 Ton Excavators
- CAT D6T Bulldozer
- Komatsu D65 Bulldozer
- Komatsu 655 Grader
- Truck and Truck Trailers
- 25 Ton Dump Truck
- Rock Breaker
- Smooth Drum Roller
- Tri-axle Spread Float



QUARRY PRODUCTS

- Road Base - 25mm & 40mm
- Rock for erosion control

For all your earthmoving needs

Simon & Kim Whitehead

Ph: 02 6076 2036 / 0408 495 468

R & S MCINNES EARTHMOVING

Equipment for hire

- 2 x 21 ton Volvo excavators
- Volvo 30 ton dump truck
- D6T CAT Bulldozer
- 10m Truck & Dog
- Cat 12G Grader
- Triaxle Float
- Log Grab
- 11 ton smooth & padfoot rollers



For all enquires please phone Richard and Samantha on 02 6076 1446 or 0408 768 246

EARTHMOVING & EXCAVATION

HILLIER CONTRACTING

- ❖ Road Construction & Maintenance
- ❖ Road Re-sheeting
- ❖ Dairy Lanes
- ❖ Culvert & Drainage
- ❖ Site Cuts
- ❖ Building Pads
- ❖ Subdivisions
- ❖ Dam Construction & Cleaning

PLANT HIRE

Full Range of Quarry Products

Phone: Office - 02 6076 1329

Greg - 0408 555 131 /

Fax: 02 6076 2240

Email: hilliercontracting@bigpond.com

Corryong Courier

Published by Moscol Group Pty Ltd

(ABN 23 154 875 573)

Shop 1 / 41 Hanson St, Corryong 3707

Printed by Newsprinters Pty Ltd - 1 McKoy Street, Wodonga, Vic 3690.

Circulation: 1100 (Stat. Dec.)

CONTACT US:-

Phone: 02 6076 1045

Email addresses:-

Editorial/news stories:

editorial@corryongcourier.com.au

For adverts (copy, bookings, remittances):

adverts@corryongcourier.com.au

For sport: sport@corryongcourier.com.au

Postal Address: PO Box 32, Corryong 3707

DEADLINES:-

Casual Display Advertising: By 5pm Friday

Classified Advertising: By 12 noon Monday

Editorial & Letters to the Editor - 12 noon Monday

General News - 12 noon Monday

Sports Results: - 12 noon Monday

RATES:-

Casual Advertising: \$5.17 per cm / single column (discounts available for multiple insertions)

¼ Page - \$198; ½ Page - \$324.50; Full Page - \$583.

Colour negotiable. Long term contract rates also available.

Classifieds: \$5.44 + \$1.59 per line (min. 4 lines).

Payment required at time of placement

Inserts: \$148.50 per 1,000

(All prices include GST)

COPYRIGHT: All advertising and editorial content of this issue is the copyright of Moscol Group Pty Ltd and cannot be used without the company's permission.

COMPLAINTS: The *Corryong Courier* is bound by the Standards of Practice of the Australian Press Council.

Important numbers

Police: Corryong 02 6076 1666

Walwa 02 6037 1394

Khancoban 02 6076 9433

Tumbarumba 02 6948 2044

Emergency 000

Ambulance: Emergency 000

Hospitals: Corryong 02 6076 3200

Walwa 02 6037 1220

Fire Brigades:

Emergency 000

Non-urgent 02 6056 3022

Towong Shire:

Corryong 02 6076 2160

Tallangatta 02 6071 5100

Snowy Valleys Council: 02 6948 9100

Taxi (Corryong): 0418 697 807

Services & Business Directory

WHAT, WHEN & WHO

ELECTRICAL

upper murray electrical
 Domestic . Commercial . Rural
 Test and tag
 Telephone and data
 Installation and maintenance
COLIN INGLIS
 phone 02 6037 1387
 fax 02 6037 1487
 mobile 0418 963 645

PLUMBING

BROWNS PLUMBING CORRYONG

Servicing the Upper Murray for over 30 years
 Licence No. VIC 24675 NSW 214998C

- PLUMBING
- GASFITTING
- DRAINAGE



COMMERCIAL & DOMESTIC
 Supply, installation & maintenance

- Gas & combustion stoves
- Carbon monoxide testing
- Wood & gas heaters
- Roofing & guttering
- Water tanks, water pumps & pressure systems
- Hot water services
- Evaporative air-conditioners
- Large range of PVC, copper pipe & poly fittings
- Sewer & drain cleaning machine
- Ditch Witch, backhoe/front end loader & horizontal borer
- Pipe & cable locator
- Backflow prevention

Colin Brown's Mobile: 0409 742 476
 Workshop: 27-31 Harris Street, Corryong
 rbbjbrown@bigpond.com

FARM REPAIRS & MAINTENANCE

Joe Elias T/A
Joey's Repairs
 On Site Services & Repairs
 24 hrs 7 Days a week

- Trucks and Machinery
- Welding
- Auto Electrical
- 5 Tonne Excavator for hire

Ph: 02 6077 1170 / Mob: 0429 110 264

MEDICAL

WALWA MEDICAL CLINIC

- Regularly visiting doctors
- ❖ Dr Barbara Hoare ❖ Dr Clare Rocznik
- ❖ Dr Ian Partridge ❖ Dr Stephanie Partridge
- ❖ Dr Susan Lumsdaine
- Same day appointments generally available
- Bulk billing for concession card holders & children 16yrs & under
- Blood/pathology tests

Phone: 6037 1222
 Appointments also available with Maternal Health Nurse.

PEST CONTROL

Trevor & Narelle Weekes
 now trading as
PEST TO KILL

- Servicing the Corryong area for all your pest control needs
- For that good old honest and reliable service

Call 0419 257 188

TYRES

Corryong Tyre & Auto

COOPERTIRES
MICKEY THOMPSON M/T
MAXXIS
BOC

Gas Agent & Equipment Partner

TriTech
 LUBRICANTS

Neuton POWER
 Revolution in Power

27 Donaldson Street, Corryong
 Ph: (02) 6076 1177 / 0457 328 123 (AH)
 E: corryongtyre@hotmail.com

CLOSED SATURDAY MORNINGS
 Service by appointment only

CRIME STOPPERS RURAL

If you have information about production of illegal drugs or any other criminal activity, phone Crime Stoppers Rural anonymously on



1800 333 000

MUSEUM ROSTER

May 20: am R Waters, pm M Jarvis
 May 21: am - help wanted, pm J Whitehead
 May 22: am - help wanted, pm J Murphy
 May 23: am & pm M Jarvis
 May 24: am & pm S Briskey
 May 25: am L Wild, pm L Tomalin
 May 26: am & pm S Briskey

MEALS ON WHEELS

RED CROSS

May 23: P Sheather & helper;
 May 24: C Smedley & B Klippel;
 May 25: L Sheather & Mitzi Paton;
 May 26: H&H Smith;
 May 27: J Craig & helper.

OP SHOP

May 21: Tully;
 May 23: am Di Brennan, pm Hazra;
 May 24: am Hazra, pm Fiona Southgate;
 May 25: am Rochelle Sandilands & Rebecca Creswell, pm Chris Harrison & Jane Spilsbury;
 May 26: am Dianne Latta & Sam Pryse, pm Lindy O'Connor & Barbara Woodhouse;
 May 27: am Sarah Harris, pm Emma Klippel.

CORRYONG HEALTH



VACCINATIONS

People aged 12 or above can pre-book via one of the following methods in the Sub-hub which operates each Wednesday from 9am - 4:00pm:

- Calling Corryong Health on 02 6076 3200 and putting your name on the list. You will receive a call back from the sub-hub staff between Tuesday and Thursday to schedule your vaccination time; or
- Calling the National Covid Hotline on 1800 675 398; or
- Web booking: [https://portal.cvms.vic.gov.au/Urgent_Care_Centre\(UCC\)](https://portal.cvms.vic.gov.au/Urgent_Care_Centre(UCC)):- Present to the UCC / Be assessed by highly trained nurse / If required a doctor will be contacted via My Emergency Doctor

Other Services:-
 Emergencies - 000
 Corryong Medical Clinic - 02 6076 3290
 Corryong Health Reception - 02 6076 3200
 Nurse on Call - 1300 606 024 (anytime)
 GP Helpline - 1800 022 222 (anytime)
 Pathology - Mon. to Frid. 8am to 12pm.

TOWONG SHIRE & PUBLIC LIBRARY

76 Hanson St., Corryong
 Council customer service and library staff are available Monday to Friday 9am to 4.30pm. Council office and library are closed on weekends and public holidays. Ph: Shire: 6076 2160 / Library: 6076 1639

UPPER HUME HEALTH SERVICE

Alcohol, Tobacco and Other Drugs support - drug withdrawal nurses and counsellors from Wodonga will visit on an outreach basis as required. Ph: 1800 657 573.

WASTE MANAGEMENT

Corryong Tip

Thursday: 3pm - 5pm
 Sunday: 12 noon - 4pm
 Public holidays - Closed
Waste Collection Days:
Tuesday: Towong, Tintaladra, Walwa, Jingellic, Lucyvale, Colac Colac
Thursday: Cudgewa Valley, Cudgewa, Nariel, Thoughtla, Biggara, Bunroy
Friday: Corryong Township, Khancoban.

For more information visit www.towong.vic.gov.au or phone 02 6071 5100 or 1300 365 222 (local call cost).

LOCAL POLICE

For all emergencies call Triple Zero - 000

For non-urgent matters call the Police Assistance Line (24/7) 131 444
 Corryong 02 6076 1666

CENTRELINK

Retirement: 132 300; Disability/Sickness & Carers: 13 2717; Multilingual Service: 13 1202; Customer Relations: 1800 050 004; Appointments: 13 10 21. Carelink: 1800 052 222.

BREASTFEEDING SUPPORT

National Breastfeeding helpline 1800 686 268. Local volunteer counsellor - Lisa Vallett 0459 707 085. Info at www.breastfeeding.asn.au.

CORRYONG FOODSHARE

Open Wednesday and Thursday 9am-1pm
 Call in and pick up what you need or call Carol on 0427 762 051 for home delivery.
 Water & household items - call Douglas on 0427 014 935.

CATHOLIC PARISH

Mass Times:- 2nd and 4th Sundays of the month
 • Christ the King, Walwa - Saturday Vigil at 4pm
 • Sacred Heart, Corryong - Sunday at 8:30am

COMMUNITY CAR

A service for those without transport to access appointments in Alb-Wodonga. Ph: 6076 3200.

BAPTIST CHURCH

89 Hanson Street
Enquiries:

Pastor Graeme Van Brummelen - (02) 60761 468 / 0488 269 393
 Service time: 10am
 Kids church: 10.30am
 Youth Group: during school term Friday nights at 7pm
 'Mainly Music': a program for babies to preschool children and their carers - Wednesdays 10.30am
 Ring Kirsty for details 0411 524 442

ANGLICAN PARISH

Eucharist at All Saints Corryong 9:30am - every Sunday
 Eucharist at Biggara 2pm - 1st Sunday
 Eucharist at Holy Trinity Cudgewa 8am - 3rd Sunday
 Enquiries: Priest-in-charge Rev Maryann Leonard on 02 6076 1057 or 0439 066 553.

See *The Grapevine* for Lent services.

PENTECOSTAL

Ambassadors of Jesus
 59 Donaldson Street
Sunday: 10.30am Worship & The Word followed by Fellowship Lunch.

Wednesday: 7.45pm: Alternate Fellowship - Ladies, Prayer, Men's, Family.
Enquiries: Pastors Douglas & Carol Allen 6076 2050 / 51. Fax 6076 2052. E-mail: aoj@corryong.net.
Catch The Fire Ministries & Rise Up Australia Prayer Meeting: 7.45 pm Sunday: First of the month at Council Chambers, Corryong

Enquiries: B Cadle 6948 4468

UNITING CHURCH

Services are held at 9.30am each Sunday, except 5th Sundays, which are at Walwa 11am.
 Cnr Donaldson & Wheeler St., Corryong

Regional Minister: Rev. Andrew Delbridge 0410 663 194

Church Council: Linda Nankervis 6077 9212

Pastoral Enquiries: Sandy Hill 6076 8273, Catherine Ross 6076 1363, Linda Nankervis 6077 9212

Hall Hire: Pamela Menere 0408 767 327

SEVENTH DAY ADVENTIST

Services will resume when restrictions allow.

LOCAL JUSTICES OF PEACE

Carol Allen - NSW & Vic. (6076 2051); Merv Ward (6076 1369); Phil Coulston (6071 2746); Tom Newton - Vic (0438 382 140); Terry Forrest (0499 579 502).

Upper Murray Sport

Blues bounce back to their best

After a lacklustre loss to Tumbarumba in round one and a workman-like win over Federals last start, Cudgewa flicked the switch to overpower Bullioh by 95 points on Saturday.

The Blues were boosted by an influx of experienced players and flew the barriers to stun the Dogs with a seven

goals to one first quarter, effectively ending the contest.

Bullioh missed an opportunity to make up lost ground in the second term when Cudgewa had three players sent from the ground but the Blues hung tough to boot four goals to one.

Mitch Pynappels continued his red hot

form and combined with Craig Lieschke, Darcy McKimmie and Jake Vinge to pump the Sherrin long and often into the Blues' forward line where Nick Brockley dominated proceedings to register 10 of their 20 goals.

Bullioh slowed the slaughter in the third term as Kelvin Wallace and Jake Curran got busy while Mackinley Haley Oneill capped off a good game with three goals but the Blues went up a gear in the last quarter to add another six goals to their tally.

In the other encounter, Tumbarumba continued on its winning ways with a comprehensive 71-point victory over a gallant Federal team.

Despite the absence of leading goalkicker, Dan Hitchens, the Roos punched holes in the Feds' defence and eight players

capitalised to amass a winning 20 goal total - led by Jim Crozier and Tyler Lampe with five and four majors respectively.

When the Swans got their hands on the ball they were able to hit the scoreboard with Jack Miller leading the way with four goals on the back of the efforts of Harry Pole, Mitch McLean and Ewan Hampton but the Roos all round strength won the day.

This week
The winless Corryong is unlikely to get on the board against Cudgewa this week now that the Blues have got their mojo back.

The Demons won't die wondering but Cudgewa will carry too many big guns in attack for there to be an upset.

Bullioh will be determined to atone for a poor performance against Cudgewa and at home, the Dogs will be aiming for a percentage boosting effort against Federals.

The Swans will provide stern resistance for a period and a sharp start could trouble the Dogs but they should have enough firepower to get the four points.

Tumbarumba has the bye.

Results
Football (per AFL Vic PlayHQ website)

Cudgewa v Bullioh Seniors
Cudgewa 7.4, 11.4, 14.9, 20.13 (133) d Bullioh 1.1, 2.3, 4.6, 5.8 (38)

Goals:- Cudgewa - N Brockley 10, K Morey 3, J Vinge 2, J McNerney 2, J Whiteley. Bullioh - M Haley Oneill 3, K Wallace 1, unknown 1.

Best:- Cudgewa - Nick Brockley, Mitch Pynappels, Craig Lieschke, Darcy McKimmie, Jack Ross,



Up for grabs: The fickle bounce of the Sherrin sends both players the wrong way.

James McNerney. Bullioh - Kelvin Wallace, Jake Curran, Mackinley Haley Oneill, Harry Nicholls, Harry Schubert.

Reserves
Bullioh 16.10 (106) d Cudgewa 2.3 (15)

U14s
Cudgewa 11.6 (72) d Bullioh 1.0 (6)

Federal v Tumbarumba

Seniors
Tumbarumba 20.17 (137) d Federal 10.6 (66)

Goals:- Tumbarumba - J Crozier 5, T Lampe 4, H Waters 3, J Read 3, J Waters 3, L Cox 2, F Debono, H Clayton. Federal - J Miller 4, M Pieper 2, C Tyrell 2, M McLean, L Hampton.

Best:- Tumbarumba - Jacob Read, Jim Waters, Connor Clayton, Henry Waters, James Crozier, James Munday. Federal - Mitchell McLean, George Galbraith, Ivan Rogers,

Ewan Hampton, Harry Pole, Justin Inthachack.

Reserves
Tumbarumba 18.10 (118) d Federal 6.3 (39)

Ladder		
Seniors	P	%
Tumbarumba	16	200.00
Cudgewa	8	149.75
Bullioh	4	89.93
Federal	4	74.73
Corryong	0	34.06

Netball results

A Grade
Cudgewa 63 d Bullioh 45, Tumba 36 d Federal 28

B Grade
Cudgewa 49 d Bullioh 36, Tumba 42 d Federal 31

C Grade
Bullioh 20 d Cudgewa 12, Tumba 44 d Federal 14

D Grade
Bullioh 21 d Cudgewa 12, Tumba 14 d Federal 9

15&Under
Bullioh 17 d Cudgewa 16, Federal 19 d Tumba 4.



Blues News

Football

Seniors: We had an awesome four quarter effort from the whole team and were able to get on top early.

It was really great to see the whole team gel together and play for one and other.

The second term was a massive effort from us with three guys sent off we were able to still kick four goals to Bullioh's one and go on to win by 15 goals.

Best - Dylan Ward (mug), Nick Brockley (10 goals), Mitch Pynappels, Craig Leischke, Darcy McKimie, Jack Ross.

Sport cont. on page 7

AUCTIONEERS - LIVESTOCK

Contact your local agents

Jeff Brindley 0428 762 554

Will Jennings 0447 766 503

Office: 02 6058 1234

Paull & Scollard Nutrien Ag Solutions

CP corcoran parker

LIVESTOCK • REAL ESTATE • MERCHANDISE

- Livestock Agents
- Rural Property Marketing

We provide the following services:

- Livestock
- Paddock Sales
- Corryong Liveweigh Scales
- Wodonga Market Sales
- Property
- Obligation free appraisals
- Auctions, Private Sales & Tenders
- Clearing Sales

Livestock: Nick Houston 0427 111 453
Cameron Hilton 0419 578 309
Property: John Honeychurch 0419 790 924

Talk to us TODAY about your Livestock & Property requirements

We know

FLUKE CONTROL

FLUKAZOLE® C PLUS SELENIUM
fluke treatment for cattle and sheep

For the control of benzimidazole-sensitive mature and immature roundworms, lungworms, tapeworms and early immature (including 2-week old fluke), immature and mature liver fluke (*Fasciola hepatica*) in cattle and sheep. An aid in controlling selenium deficiencies.



FLUKARE® C PLUS SELENIUM
fluke treatment for cattle and sheep

For the treatment of susceptible early immature, immature and mature liver fluke (*Fasciola hepatica*) in cattle, sheep and goats. An aid in controlling selenium deficiencies.



NITROFLUKE® INJECTION

For the treatment and control of nitroxylin and clorsulon sensitive strains and triclabendazole resistant strains of early immature (inc 2-week old), immature and adult liver fluke (*Fasciola hepatica*) in cattle.



Agmate Rural Services
33 Donaldson Street, Corryong VIC 3707 Ph: 02 6076 1166

There's always better value at CRT.
www.crt.com.au

