

# Corryong Courier

Circulating throughout WALWA, KHANCOBAN, CUDGEWA and CORRYONG DISTRICTS

Published by Moscol Group P/L ABN 23 154 875 573. Print Post Approval No. 100002892.

Address: 1/41 Hanson St, Corryong, 3707 / PO Box 32, Corryong, 3707. Ph: (02) 6076 1045

Website: www.corryongcourier.com.au. E-mail: editorial@corryongcourier.com.au / adverts: adverts@corryongcourier.com.au

Single copy \$1.70 (GST inc.) / \$140.00 p.a. posted (GST inc.) / \$74.99 p.a. online (GST inc.)



THURSDAY JULY 28, 2022

\$1.70 INC

## Corryong Newsagency

43 - 49 HANSON STREET, CORRYONG  
Phone: 02 6076 1381 / FAX: 02 6076 1188  
Email: info@corryongnews.net.au

**TattsLotto**  
Wouldn't it be nice

**\$30 MILLION MEGADRAW**

Sat 30 July

The Lott Official Home of Australia's Lotteries



**O'CONNELLS**  
REFRIGERATION & AIRCONDITIONING

WHEN THE TEMPERATURE HITS YOU

**FUJITSU FREE MONEY**  
WORTH UP TO \$450

**JUST GET A FUJITSU!**

RECEIVE A FUJITSU DIGITAL PREPAID MASTERCARD\* WORTH UP TO \$450 WHEN YOU PURCHASE THE FOLLOWING:

- UP TO \$200 on selected COOLING ONLY SPLIT SYSTEMS
- UP TO \$250 on selected REVERSE CYCLE SPLIT SYSTEMS
- UP TO \$400 on selected MULTI SYSTEMS
- UP TO \$450 on selected DUCTED SYSTEMS

\* Purchase by 4:59pm AEST 31/08/21. Claim by 4:59pm AEDT 29/10/21. Domestic and residential purchases only. Eligible models only, see website for list. Exclusions apply, see full terms and conditions. Proof of purchase and payment required. Customers will need their outdoor model and serial numbers and indoor model number to complete their claim. Full terms and conditions available at [fujitsu-general.com.au/promotions](http://fujitsu-general.com.au/promotions). The Fujitsu Prepaid Mastercard is issued by EML Payment Solutions Limited ABN 30 131 436 532 AFSL 404131 pursuant to license by Mastercard Asia/Pacific Pte. Ltd. Mastercard is a registered trademark, and the circles design is a trademark of Mastercard International Incorporated. Mastercard prepaid cards can be used at all merchants that accept Mastercard prepaid cards. Terms and conditions apply. Promoter is Fujitsu General (Aust.) Pty Limited (ABN 55 001 229 554) of 1 Telopea Place, Eastern Creek NSW 2766.

Contact us now for more details  
Ph: 02 6059 3222  
2/20 Mint St., Wodonga

**ARCtick**  
CERTIFIED  
AU06286

**IGA** plus LIQUOR

24-30 Hanson St., Corryong. Ph: 6076 1286

**GREAT SPECIALS**

**1/2 PRICE**

- Cadbury Favourites 332-375g Selected Varieties **\$7** SAVE \$7
- Bulla Ice Cream Slides 6x14 Pack Selected Varieties **\$3.75** SAVE \$9.75
- Bulla Splits **\$3.75** SAVE \$9.75
- Oreo Cookies 133-147g Selected Varieties **\$1** SAVE \$1
- Optimum Dry Dog Food 2.5-3kg Selected Varieties **\$14.50** SAVE \$6.50

Specials end 2nd August 2022

## Road closure riles residents

Landholders on Towong Hill Road are up in arms over the closure of the Towong Bridge while a new structure is being constructed, claiming that they were ignored in the planning process and that they are incurring extra costs because of unnecessary detours.

One of the most vocal protestors has been Towong Hill Road resident, Mark Auchinleck, who said that in the initial Transport for NSW briefing for locals in March 2022 it was never mentioned that the road would be closed.

Once it was evident that it would be shut for the duration of the demolition and new construction phases, landholders requested that the allocated pedestrian and cyclist passage be widened by about two metres to allow them tractor and ATV access.

A Transport for NSW spokesperson said that Towong Hill Road was closed due to the set-up of the site compound on the Victorian side of the Murray River for the construction of the new Towong Bridge.

"Work on the new

bridge is being carried out from both the Victorian and NSW sides of the river," they said, "and site compounds have been set up either side of the river for the duration of the bridge construction.

"The size of each compound space has carefully been considered to ensure the safety of workers and the community.

"Transport for NSW and the contractor, Nelmac Pty Ltd, have ensured the size of the site compound has been kept to a minimum. There is no opportunity to reduce the size of the compound while being suitable for the large equipment with heavy loads that will be operating in this space.

"While Towong Hill Road is closed, alternative routes are available via the local road network."

**ELECTRICIAN**

Test & Tag Service

**Robbie Burrows**  
0418 138 674

E: robbie01@bigpond.com  
REC 30313 - mutual recognition in NSW

Story continued page 2

# BACASH'S EMPORIUM

We stock a great range of Clothing, Fabrics, Bedding & Towels Find a treasure in Bacash's Attic

## OPENING HOURS

Monday ..... 9am to 4pm  
Tuesday ..... 9am to 4pm  
Wednesday..... CLOSED  
Thursday ..... 9am to 4pm  
Friday ..... 9am to 4pm  
Saturday ..... 9.30am to 1pm

23 Hanson St. (in the heart of Corryong)

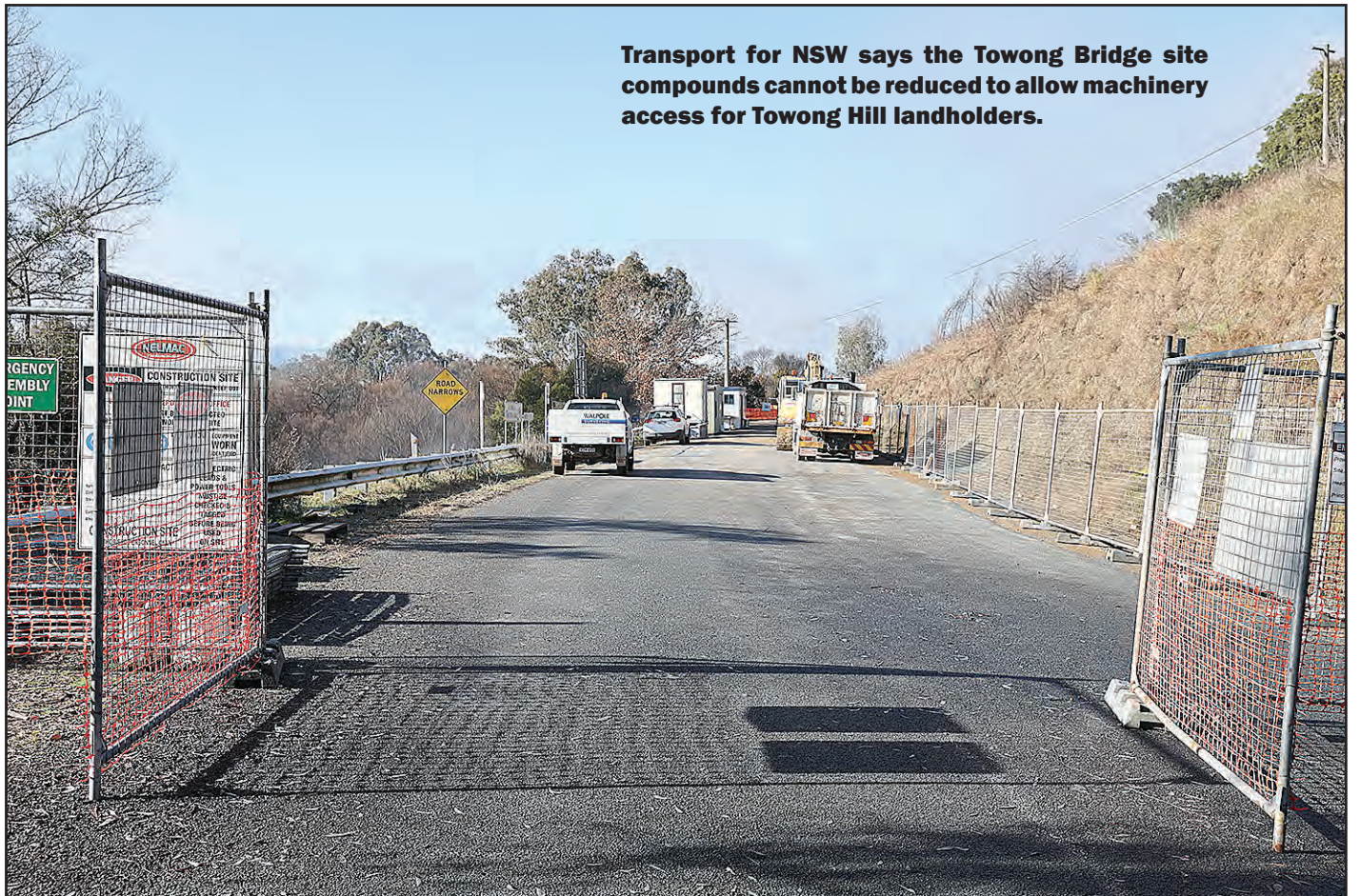

Transport for NSW says the Towong Bridge site compounds cannot be reduced to allow machinery access for Towong Hill landholders.

## Bridge detours cause cost increases

Cont. from page 1.

Mr Auchinleck said that it had been frustrating that the road remain closed even when work was not being carried out at the

site. "Equally annoying and frustrating is why the road has to remain closed after hours, at weekends, for public holidays and when

bad weather prevents work," he said.

"Even when work is occurring, what difference is there between pedestrians and cyclists passing the site and our tractors or ATVs doing the same thing - more rapidly than someone on foot - and only causing a few seconds interruption two or three times weekly?"

"In September landholders will need to start spraying weeds on various properties, silage harvest happens in October and in November fire season starts. If the road remains closed we will be left with only one way in and out.

"Using cross country tracks in winter is not an option as they are unsafe when wet and in winter. That apart, one lane should be kept open for emergency vehicles.

"The suggestion that

emergency vehicles can simply move the barrier and drive through is not acceptable to local CFA, SES or health service personnel that I have contacted."

Mr Auchinleck also said that landholders should be recompensed for the additional costs they incur by having to use the detours.

"This cost could more easily be borne if the construction phase was not so long but right now it is grossly unfair," he said.

"Transport for NSW should have properly engaged in the planning phase with those in the community most likely to be adversely affected and financially disadvantaged and made suitable provision. A few thousand dollars on top of a \$10 million contract is little more than rounding."

Mr Auchinlek added

that he had also contacted the Towong and Snowy Valleys Councils and members of Parliament on both sides of the Murray River to see what could be done about improving access and compensating landholders.

The Transport for NSW spokesperson said that it is committed to completing the new bridge as quickly as possible, with a target completion date of mid-2023.

"We understand the work comes with some inconvenience and appreciate the community's understanding while work is carried out," they said.

"The site compounds have been set up to cater for the entirety of the work and are unable to be removed or amended intermittently due to safety and efficiency considerations."

## Decision on mayor's allowance held over

At its July meeting, Snowy Valleys Council (SVC) deferred a report on setting a new mayoral allowance to its August meeting to allow for

further information to be provided.

The decision followed a robust discussion about potential impacts of a fee increase on council

finances and the process to be followed to meet the requirements of the Code of Meeting Practice.

Council had met in Tumut and while it was open to members of the public, due to technical difficulties it was not livestreamed as intended.

Interim General Manager, Hamish McNulty, said despite best efforts the meeting was recorded without audio.

"Staff tried a couple of different approaches to fix the problems but unfortunately while there is a video recording of the meeting, we were unable to repair the audio issues," he said.

Following the close of the meeting Mayor Ian Chaffey and Deputy Mayor Trina Thomson recorded a short summary of proceedings where they discussed some of the decisions made.

Cont. on page 3.



If you have information about production of illegal drugs or any other criminal activity, phone Crime Stoppers Rural anonymously on

1800 333 000

www.vic.crimestoppers.com.au

## WHAT'S ON @ THE BOTTOM

CORRYONG HOTEL MOTEL

This Saturday 30th July 8pm



COURTESY BUS AVAILABLE

PH: (02) 6076 1004

EMAIL: INFO@CORRYONGHOTELMOTEL.COM.AU

WEB: WWW.CORRYONGHOTELMOTEL.COM.AU

SEE YOU @ THE BOTTOM

## FOCUS PARTNERS

OUR NEXT CORRYONG VISIT WILL BE Wednesday August 17, 2022

• Tax Returns • Business Advice • Accounting Services • Financial, Investment & Retirement Planning Advice

Ph: 02 6021 3399

office@focuspartners.com.au

81 Hanson Street, Corryong

FOCUS PARTNERS - OUR FOCUS IS YOUR FUTURE

# Retiring retailer saw a raft of changes

When she started as a young sales assistant in Wagga, Robyn Stockwell recalled that most goods were wrapped in paper as there were no such things as plastic bags, which were introduced in supermarkets in the 1980s.

"It's all come full circle," Robyn mused recently. "Now they're getting rid of plastic bags!"

After 60 years in the retail sector Robyn is retiring and closing her business Corryong Footwear.

She has seen a multitude of changes in those six decades particularly the growth of large department stores and increasing popularity of online shopping.

"I have decided to close the shop as I didn't want to sell it to someone only to see them go broke," Robyn said.

"Nowadays people mainly want athletic style shoes and the big brands don't want to supply

small businesses like mine because it doesn't fit their image.

"The big sports stores like Rebel can offer a wider variety of footwear and it's easier for people to travel to the larger shopping centres like Albury Wodonga than it was in the past."

Robyn began her retail career as a 13-year-old working for Cummins General Store in Wagga after school and on weekends.

"They sold almost everything except clothing," she said.

"I remember that a loaf of bread cost one and halfpence and we would wrap it in greasproof paper for the customer."

Robyn (below) became a permanent employee with Cummins when she was 15 years of age, earning £2 10/- (about \$5) for a 5½ day week.

She then moved to Corryong in 1966 to begin work as a domestic staffer



at the Corryong Hospital.

The following year she married Colin Stockwell, who she had met in Wagga through a family connection.

The couple then relocated to Bacchus Marsh for a year where Robyn moved back into retail employment.

Upon their return to Corryong, they had two children - Paul in 1969 and Kim in 1972.

In 1977 she began work for Jack and Lena Cross at Jakaleens Hardware where she was employed for nine years before purchasing the shoe section from them - which was located in what is now the BankWAW building - and so started Corryong Footwear.

The business subsequently moved

into a right-side space in Bacash's Emporium in 2002 before relocating to its current site in 2007.

Robyn has taken much pleasure in 'shoeing' the people of the Upper Murray community and noted that she had served up to five generations of several families in the district from great great grandmothers down to one-year-olds.

She also felt a responsibility to the community's wellbeing and served in various roles with local community groups.

She has held the position of treasurer with the junior basketball association, Corryong Football Club Ladies Auxiliary and Corryong Chamber of Commerce.

Robyn has been a keen

advocate for her adopted town and initiated Santa's visit each year as well as the Christmas street lights and trees and late night shopping and the Easter Bunny's annual appearance.

She also help maintain the original gardens in the median strip established by the Lions Club.

She is also a volunteer at the Visitor Information Centre in Corryong.

Corryong Footwear also became a regular meeting place for Robyn's cohorts where the 'local affairs of state' were discussed.

"I will miss my customers and the regular visitors who returned to town and those people who just dropped in for a chat but the time has come to retire and go travelling."



**Specialising in colour work**  
For all your printing needs  
Contact Mark Collins  
0418 602 623

**John Hossack FUNERAL SERVICES**  
*Always caring*

*The ultimate funeral care for your loved one*

Ph: 02 6041 3855 • 435 Wilson St, Albury  
www.hossackfunerals.com.au

## Council aims for financial sustainability

Cont. from page 2.

The summary video was posted to council's facebook page on the evening following the meeting and can also be viewed on SVC's YouTube channel.

The meeting began with a notice of motion from Cr Hughes regarding ongoing management of the Batlow Caravan Park, and councillors agreed to retain the current operating model for now while an overall Snowy Valleys Caravan Park Strategy and Business model is scoped.

Other matters from the meeting included:-

- Presentation of the annual 2021/22 SVC Sustainability Plan report including the progress and status of 35 actions, with councillors making a commitment to support ongoing efforts to achieve financial sustainability.

- Approval was granted to rename the western end of Mitchell Avenue in Khancoban to Clews Road after Major Hugh Powell Gough Clews.

- In principle non-financial support was given to the Tumut Lion's Club reservoir artwork project with council asking staff to prepare a further

report reviewing and assessing various artwork treatment options and the financial implications for construction and any ongoing maintenance.

- The 2021 Drinking Water Management System Annual Report was endorsed for submission to NSW Health.

- The feasibility of subdividing McMeekin Street Tumarumba - Lot 1 DP 1148834 - as opposed to selling as a single lot, is to be investigated.

- Activities held in celebration of the 2022 NAIDOC week were noted and council

agreed to engage with the Aboriginal Liaison Committee on further possible events for the coming years.

Business documents and minutes can be viewed on council's website at [www.svc.nsw.gov.au/21-July-2022](http://www.svc.nsw.gov.au/21-July-2022).

The next ordinary meeting of council will be held on Thursday August 18, 2022, starting at 2pm.

The agenda and business papers will be available on council's website or by contacting the customer service team one week before the meeting date.

### Corryong Neighbourhood Centre

**Position Vacant** - Upper Murray Community Bakery is seeking reliable front of house staff. Must be available weekdays and early mornings. - Please speak to Sara at the CNC for more info.

**Upper Murray Employment Group** - Join the Facebook group to advertise or find employment  
**Good Shepherd NILS** - No interest loans for Centrelink recipients - Contact Nikki 0429 024 717  
**Hume Riverina Community Legal** - Free legal advice - Visiting fortnightly - Call 1800 918 377  
**Youth Space** - Open after school - All 12-24-year-olds welcome - WIFI, Nintendo switch, PlayStation, boardgames, pool table, art on Wednesday afternoon and more to enjoy!  
**Skills & Jobs Centre** - Visiting first Tuesday of every month - 10am - 12pm - Assisting with employment & training - Resumes, applications, employer incentives, traineeships & more!

THANK YOU FOR SUPPORTING THE CNC SOCIAL ENTERPRISES  
**Upper Murray Community Bakery** - Open Monday - Saturday - Phone 02 6076 1196  
**Upper Murray Community Garage** - Open Monday - Thursday - Phone 02 6037 1587

**CENTRELINK & VICROADS AGENCY**  
 PRINTING - SCANNING - LAMINATING - PASSPORT PHOTOS - FREE INTERNET ACCESS - TECHNICAL ASSISTANCE - GENERAL INQUIRIES

**CNC** 39 Hanson St, Corryong Vic 3707 ABN 38 793 076 812  
 Ph: 02 6076 2176 Email: [admin@corryongnc.org](mailto:admin@corryongnc.org)

## ALL THINGS WORKWEAR

...That's what we do better!

**AG Warehouse Bamboo Work Socks - 3pk**  
Size 6-10 500857  
Size 11-14 500858

**NEW**

**KingGee**  
Women's & Men's King Gee Bamboo Socks

- Assorted colours
- Made in Australia.

**KAIWAKA**  
kaiwakaobthings.co.nz

**Kaiwaka Everyday Range**

- Elasticated waists
- Welded seams • Top quality
- Great value for money.

**Everyday Parka**

- Double stormflap over zip with dome fasteners
- Safety strip for better visibility
- Full head protection
- Heavy duty zip
- Two large pockets.

**Everyday Overtrousers**

- Right hand side entry
- Safety strips around each leg.

**Everyday Bib Overtrousers**

- Elasticated shoulder straps
- Right hand side entry
- Safety strips around each leg
- Full front protection
- Large internal chest pocket.

989 Murray Valley Hwy, Corryong Ph: 02 6076 1288 Open: Mon - Fri 8am - 5pm Sat 9am-12pm [agwarehouse.com.au](http://agwarehouse.com.au)

# Street to be named after early surveyor

The western end of Mitchell Avenue in Khancoban will be renamed Clews Road after Major Hugh Powel Gough Clews, following community feedback.

Snowy Valleys Council (SVC) mayor, Cr Ian Chaffey said "Major Clews spent a significant amount of time carrying out surveying work around Khancoban prior to the commencement of the Snowy Hydro Scheme back in the 1950s, so I think the community is certainly happy about the fact that his contribution has been acknowledged by naming the road after him," he said.

The portion to be renamed Clews Road is the western end of Mitchell Avenue from Scott Street to the intersection of Douglas Street and Chisholm Street.

The renaming seeks to rectify addressing issues for a small number of properties on Mitchell Avenue which is impacting on the ability of emergency responders,

utility providers and delivery services to provide timely service.

Following an original proposal to rename the road Wallaby Avenue, council reached out to the local community for feedback.

A Khancoban 'pop-up' was held in early June to provide opportunity for locals to discuss the road naming proposal and to provide other suggested name possibilities.

Community feedback indicated a preference for Clews Road or Lady Hudson Road and council selected the former as it already had Geographic Naming Board approval.

Major Clews was a Senior Surveyor for the Snowy Mountains Authority and was in charge of mapping the Snowy Mountains from 1950 to 1958.

Council staff will now serve notice of the road name to Australia Post, the Registrar General, the Surveyor General, and formally have the name gazetted.



Major Clews surveyed much of the Snowy Mountains throughout the 1950s.



Johnny Murray will provide an Aboriginal voice on water management.

## New appointment will bring about change

North East Water is proud to announce the appointment of Duduroa and Yorta Yorta man Johnny Murray as an independent Aboriginal delegate of the corporation's board of directors.

Mr Murray has been appointed for a 12-month period and is the organisation's second Aboriginal delegate engaged since 2019.

Chair, Cath Botta, said Mr Murray has extensive experience working with Aboriginal and Torres Strait Islander communities across the country.

"Johnny will be able to provide insight into matters relating to urban

water management and its connection to traditional owners," she said.

"It's also an opportunity for him to consider a future full directorship within the water sector. Not only does the delegate role provide greater perspectives in the corporation's strategic discussions, it also continues to strengthen our relationships with Aboriginal communities.

"North East Water is on a reconciliation journey and we're excited to be taking these steps towards an inclusive and just country.

"I am extremely excited that Johnny is joining our team and I'm looking forward to his first board meeting."

Mr Murray added "I am a proud Aboriginal man and have a great understanding of Aboriginal cultural protocols across north-east Victoria, southern New South Wales and Queensland.

"I believe Aboriginal people and communities should have a say in all matters that affect them and this position will provide a great opportunity for an Aboriginal voice at North East Water.

"I am committed to bringing about positive change whilst working together towards improving outcomes for Aboriginal people and North East Water as a collective."

## Residents urged to take up power bonus

More Victorians can receive immediate bill relief and cut their energy costs thanks to the government's \$250 Power Saving Bonus, which has already been taken up by one million households.

Last week Minister for Energy, Lily D'Ambrosio, announced a \$205 million boost to the popular program, where every Victorian household can receive \$250 to seek out a better energy deal on Victoria's Energy Compare website.

All Victorian households are eligible for the payment, including the nearly 400,000 concession card holders who previously claimed the payment under an earlier phase of the program.

"We know Victorian families are doing it tough, so we're topping up the \$250 Power Saving Bonus program to make sure no one misses out," Ms D'Ambrosio said.

The \$250 Power Saving Bonus is available until 30 June 2023 and there are no caps on the number of households that can receive the once-off payment. User data shows that over the past 12 months, seven out of every 10 users saved an average of \$330 by switching energy offers. Households can claim the \$250 payment by heading to the Victorian Energy Compare website and comparing energy offers to see if they can get a better deal or by engaging with a

participating community outreach partner.

The Victorian Energy Compare website is the only free and independent online energy price comparison service available to the state's energy consumers. Other programs helping households and businesses to slash energy bills include Victorian Energy Upgrades, which provide upfront incentives for low-cost-to-free energy efficient products and Solar Victoria, which offers households and businesses discounted solar panels, batteries and efficient heating and cooling. To apply and for more information go to [compare.energy.vic.gov.au](http://compare.energy.vic.gov.au).

## The Grapevine

Community members are invited to a special event - Corryong Spirit - on Friday August 12, 2022 at Attree Park to acknowledge those whose lives were lost after the 2019 bushfires and to recognise the courageous people who have endured related hardship on many levels. See next week's issue for more information.

❖  
Club Corner:- The Joker Poker jackpot at The Club Corryong this Friday is \$2250. Last week's winner was Louise Curven (\$50). Footy tipping: Cade Heinjus & Peter McNamara 114; Shirley Turnham & Cheryl Lloyd 113.

❖  
Items of local interest for this column can be emailed to [editorial@corryongcourier.com.au](mailto:editorial@corryongcourier.com.au).

**Lester & Son**  
Funeral Directors  
*A tradition of personal, professional care since 1907*

**Cherie Wright Tony Egan John Vogel**

**02 6056 1700**  
49 Thomas Mitchell Drive Wodonga

# Delivering for our community

As your Independent MP, you can count on me. I am your strong voice, working each and every day to advocate for you, your family and our community.

My office assists thousands of constituents with NDIS, Centrelink, Medicare, My Aged Care, telecommunications and immigration issues. My office is open 9am - 5pm weekdays. If you need help with any Commonwealth service, please phone, email or visit my office.

**Helen Haines** MP

Wangaratta / 117 Murphy Street  
03 5721 7077  
Wodonga / 79 High Street  
02 6024 6284

[helenhaines.org](http://helenhaines.org)  
[@helenhainesindi](https://twitter.com/helenhainesindi)  
[helen.haines.mp@aph.gov.au](mailto:helen.haines.mp@aph.gov.au)

INDEPENDENT FEDERAL MEMBER FOR INDI

Authorised by Helen Haines 117 Murphy St Wangaratta VIC 3677



ADVERTISEMENT

**Increased bushfires put pressure on timber supply.**



**Forest management needs to ramp up**

An independent review of the Victorian Regional Forest Agreement regions after the devastating 2019-20 bushfires has backed industry calls for active management across all land tenures.

The Commonwealth and Victorian governments agreed to undertake a Major Event Review to assess the impacts of the fires and identify future action.

Deb Kerr, CEO of the Victorian Forest Products Association (VFPA), said the report - overseen by an independent panel and informed by science, traditional owner knowledge and public consultation - highlights the need for active and adaptive forest management.

The report recommends the governments "further investigate the mechanical thinning of dense regrowth forests as a strategy to restore forest landscapes to a more open forest structure in order to enhance the resilience of forests to more frequent occurrence of severe bushfires."

Several recent peer-reviewed scientific studies that have shown forest thinning - as practised in Victoria's sustainably managed timber production forests - significantly reduces bushfire severity.

Other key findings of the report, which includes 37 recommendations for improvements on how to manage Victorian forests included:-

- Mechanical thinning

of regrowth forests

- Active forest management and forest resilience to repeated high-intensity bushfires

- Outcomes for traditional owners through empowered active involvement in forest management

- Research, data, and information on Regional Forest Agreement (RFA) values and bushfire impacts

- Preparation for future Major Event Reviews.

Ms Kerr said Victoria's forest industries were already doing their part to improve conservation outcomes following major bushfires.

"This report is part of a broader discussion about the loss of biodiversity due to major bushfires," she explained.

"Forestry already responds to these risks, for example through a dedicated Greater Glider Conservation Strategy put in place by VicForests in 2019 as well as additional protection of endangered species. This approach is consistent with the conservation advice for recently upgraded EPBC Act listing of the species.

"At the same time, increased bushfires put additional pressure on timber supply. The report finds that Victoria's privately-owned softwood and hardwood plantations were also significantly impacted by the 2019-20 bushfires, with a total of 8,354 hectares worth an estimated \$75 million destroyed.

"The increasing impact of bushfires on plantations

presents an escalating threat to wood-processing industries in Victoria.

"We have some of the most sustainable forestry practices in the world - and this report underlines the need for active forest management rather than a 'lock up and leave' approach that some demand," Ms Kerr said.

Australian Forest Products Association (AFPA) CEO, Ross Hampton, said the report echoed the findings of the Commonwealth's State of the Environment report card released last week.

"These reports confirm that we need a rethink about how we manage our vast native forest estate, particularly the tens of millions of hectares that have been set aside for permanent conservation yet are failing to stem the decline of our native species," Mr Hampton said.

"It is clear that the tiny fraction of area harvested each year for timber production and regenerated by law is not the culprit. Australia's sustainable forestry operations are regulated to the highest standards in the world for forest management and its our forestry workers who are on the frontline fighting bushfires saving lives and homes."

AFPA released a report after the Black Summer bushfires calling for a national mechanical fuel reduction program, *Using Fire and Machines to Better fireproof Our Country Towns*.

**Active Bystander Training**



**Tallangatta and Corryong sessions**

**Gain the knowledge, tools and motivation to stop inappropriate behaviour in the workplace and the wider community by attending an Active Bystander Training session.**

Active bystanders are valuable allies in combating disrespectful behaviour and attitudes, particularly towards violence against women, and play a pivotal role in preventing incidents from occurring in the first place.

We will be running two free sessions:

**Tallangatta**

Date: Monday 8 August 2022  
Time: 10:30am-1:30pm  
Venue: Tallangatta Library

**Corryong**

Date: Monday 29 August 2022  
Time: 10:30am-1:30pm  
Venue: Upper Murray Community Recovery Hub

Bookings are limited. Secure your spot now at [www.towongshirecouncil.eventbrite.com.au](http://www.towongshirecouncil.eventbrite.com.au).

For more information about Active Bystander Training head to [www.whv.org.au/training/active-bystander-training](http://www.whv.org.au/training/active-bystander-training).



**Advertising that pays dividends**  
**Corryong Courier**

**Online advertising also available**

**Email: [adverts@corryongcourier.com.au](mailto:adverts@corryongcourier.com.au)**

**Together we're building Resilience in the Upper Murray**



Jobs, Precincts and Regions



**PUBLIC NOTICES**



**Walk-in Covid-19 Vaccination Clinic**  
**Thursday August 4, 2022**  
**10:30am to 2:00pm**  
**Corryong Events Centre**  
**Strzelecki Way, Corryong**  
 No appointments required  
 • Pfizer vaccine for adults and children  
 • Novovax for adults

❖

**Corryong Medical Clinic**  
**Covid Vaccination**  
**Adults - Pfizer only**  
**August 4th, 5th & 6th, 2022**

Ring the clinic on 02 6076 3200 for a vaccination appointment.  
 Clinic staff will place you on the waiting list and ring you back when an appointment time becomes available.

**Caring for the Upper Murray**  
 Together, strengthening the health of our community

**FOR SALE**

**Fishing Combo** - Tinnie and trailer (reg. X44-782), lots of extras, \$1100. Ph: 02 6076 1252 and ask for Trevor.

**DEATHS**

**LEBNER**

**Charles George Leonard (Len)**

21.5.1927-24.7.2022  
 Aged 95 years.

Dearly loved husband of Betty (dec.). Much loved father to Prue, Marty, Tom and Fairlie and father-in-law to Charlie, Kerry, Sally and Peter. Love Poppy Len to all his grandchildren and great grandchildren.

❖  
 A funeral service will be held on Friday August 5th, 2022 at the All Saints Anglican Church, Corryong at 11am; followed by interment at the Corryong Cemetery.



**Lester & Son**  
 Ph: 02 6056 1700

**McINNES, Lynn** - Memories of you Lynn are ours to keep. Rest peacefully in God's garden. ~ Nonie, Donna and family.

**Upper Murray Sport**

**Local riders take on the challenge**



**Enduro riders (from left) Reece Findlay, Maison Bloom, Riley Bloom and Layne Klippel prepare to take on the tough Bonnie Doon course.**

Four young motorbike guns took on a tough course in the recent third round of inaugural Victorian Hard Enduro Championship at Bonnie Doon.

The Hard Enduro series comprises six events under the auspice of the Australian Motorcyclist Association and kicked off with the Kosciuszko Killer

at Corryong in April.

The 'Boney Doom' course was designed to be challenging and physically demanding comprising

logs, rocks, hills, water, mud and various obstacles.

Four local riders took on the course with Reece Findlay winning the Junior

A class and Layne Klippel finishing second in Junior B while Riley and Maison Bloom also performed well.

**CORRYONG TAXI SERVICE**  
 Servicing Corryong & District  
**0418 697 807**

**Ken Bailey Mechanical Repairs**  
 46 Donaldson St Corryong  
 Ph: 6076 1119

**CHIROPRACTOR IN CORRYONG**  
**Dr Rowan Daniel**  
 Visiting weekly on Fridays 9.30am-5.30pm  
 Next appointments: August 5, 2022  
 81B Hanson St., Corryong  
 Ph: 6056 2185

**MEETINGS**  
**Corryong Golf Club**  
**General Meeting**  
 Wednesday August 3, 2022 - 5.30pm  
 The Club Corryong  
 • All golfers invited to attend to have their say

**POSITIONS VACANT**



**Career Opportunity**

Want to join Team Towong?

We are looking for a passionate and qualified Educator to join our team at the Early Years Learning Centre in Walwa.

Applications close Sunday 7 August.

**Apply at [towong.vic.gov.au](http://towong.vic.gov.au)**

**MEETINGS**

**GET INVOLVED**

**CORRYONG BASKETBALL**



**ANNUAL GENERAL MEETING**  
**COME JOIN US**  
 TOWONG SHIRE MEETING ROOMS (TBC)  
 MONDAY 1ST AUGUST 7-9PM

**NEW COMMITTEE REQUIRED - ALL POSITIONS VACANT**



**Employment Opportunities**

Please check our website for current employment opportunities: [www.corryonghealth.org.au/employment](http://www.corryonghealth.org.au/employment)

"Corryong Health is an Equal Opportunity Employer; we encourage applications from Indigenous Australians, people with disabilities, young people and people from culturally diverse backgrounds"

**Caring for the Upper Murray**  
 Together, strengthening the health of our community

**Corryong Indoor Bowls**

**Results R10 25/7/22**

Attackers d Pole Cats 22-6, CNC d Bacashes 17-15, Hoppers d Lucyvale 17-9, Courthouse d Bandits 20-10, Thoughla d St George 19-8, AFL d Indiettes 21-8.

| Ladder     |    |      |
|------------|----|------|
| A Grade    |    |      |
| Courthouse | 32 | +65  |
| Thoughla   | 32 | +40  |
| Bacashes   | 30 | +58  |
| AFL        | 28 | +69  |
| B Grade    |    |      |
| Attackers  | 20 | 16   |
| Bandits    | 20 | +12  |
| CNC        | 20 | +9   |
| Lucyvale   | 18 | -23  |
| C Grade    |    |      |
| Indiettes  | 18 | -28  |
| Hoppers    | 16 | -23  |
| Pole Cats  | 4  | -122 |
| St George  | 2  | -72  |

**Draw R11 1/8/22**

AFL v St George 4, Indiettes v Bacashes 6, Thoughla v Courthouse 3, CNC v Hoppers 5, Bandits v Pole Cats 1, Lucyvale v Attackers 2.

**Men's Pairs Final: Craig McKimmie & Ron Pynappels v Rohan and Brett Whitehead.**

**Finals 8/8/22**



**High Country Darts**

**Results R11 26/7/22**

Possum Pointers d Brumbies 4-3, Bottom Pub d Tinpot 6-1, Biggara d Bottoms Up 4-3.

| Ladder     | P  | %     |
|------------|----|-------|
| Bottom Pub | 36 | 185.2 |
| Brumbies   | 36 | 133.3 |
| P/Pointers | 28 | 123.5 |
| Tinpot     | 20 | 113.9 |
| Bottoms Up | 8  | 63.8  |
| Biggara    | 8  | 45.3  |

Sharpshooters  
 Highest peg: M Russell 111; Men's highest score: Paul Cox, 180; Ladies' highest score: Andrea Carmody 112.  
 Draw: R12 2/8/22  
 Bottom Pub v P/Pointers  
 Brumbies v Bottoms Up  
 Biggara v Tinpot/

**TENDERS**



**Request for Tender**

We are seeking a qualified contractor to undertake upgrade works on the Omeo Highway and La Fontaine Street intersection in Mitta Mitta.

Submissions close Monday 15 August.

**Visit [towong.vic.gov.au](http://towong.vic.gov.au)**

**Send your sports reports and photos to: [editorial@corryongcourier.com.au](mailto:editorial@corryongcourier.com.au)**

**PUBLIC NOTICES**



**Walk-in Covid-19 Vaccination Clinic**

**Thursday August 4, 2022  
10:30am to 2:00pm**

**Corryong Events Centre  
Strzelecki Way, Corryong**

- No appointments required
- Pfizer vaccine for adults and children
- Novovax for adults

**Corryong Medical Clinic  
Covid Vaccination**

**Adults - Pfizer only  
August 4th, 5th & 6th, 2022**

Ring the clinic on 02 6076 3200 for a vaccination appointment.

Clinic staff will place you on the waiting list and ring you back when an appointment time becomes available.

Caring for the Upper Murray  
Together, strengthening the health of our community

**FOR SALE**

**Fishing Combo** - Tinnie and trailer (reg. X44-782), lots of extras, \$1100. Ph: 02 6076 1252 and ask for Trevor.

**DEATHS**

**LEBNER**

**Charles George Leonard (Len)**

21.5.1927-24.7.2022  
Aged 95 years.

Dearly loved husband of Betty (dec.). Much loved father to Prue, Marty, Tom and Fairlie and father-in-law to Charlie, Kerry, Sally and Peter. Love Poppy Len to all his grandchildren and great grandchildren.

A funeral service will be held on Friday August 5th, 2022 at the All Saints Anglican Church, Corryong at 11am; followed by interment at the Corryong Cemetery.



**Lester & Son**  
Ph: 02 6056 1700

**McINNES, Lynn** - Memories of you Lynn are ours to keep. Rest peacefully in God's garden. ~ Nonie, Donna and family.

**Upper Murray Sport**

**Local riders take on the challenge**



**Enduro riders (from left) Reece Findlay, Maison Bloom, Riley Bloom and Layne Klippel prepare to take on the tough Bonnie Doon course.**

Four young motorbike guns took on a tough course in the recent third round of inaugural Victorian Hard Enduro Championship at Bonnie Doon.

The Hard Enduro series comprises six events under the auspice of the Australian Motorcyclist Association and kicked off with the Kosciuszko Killer

at Corryong in April.

The 'Boney Doom' course was designed to be challenging and physically demanding comprising

logs, rocks, hills, water, mud and various obstacles.

Four local riders took on the course with Reece Findlay winning the Junior

A class and Layne Klippel finishing second in Junior B while Riley and Maison Bloom also performed well.

**CORRYONG TAXI SERVICE**

Servicing Corryong & District  
**0418 697 807**

**Ken Bailey Mechanical Repairs**

46 Donaldson St Corryong  
Ph: 6076 1119

**CHIROPRACTOR IN CORRYONG**

**Dr Rowan Daniel**  
Visiting weekly on Fridays 9.30am-5.30pm  
Next appointments: August 5, 2022  
81B Hanson St., Corryong  
Ph: 6056 2185

**MEETINGS**

**Corryong Golf Club**  
General Meeting  
Wednesday August 3, 2022 - 5.30pm  
The Club Corryong  
• All golfers invited to attend to have their say

**POSITIONS VACANT**

**Career Opportunity**

Want to join Team Towong?

We are looking for a passionate and qualified Educator to join our team at the Early Years Learning Centre in Walwa.

Applications close Sunday 7 August.

**Apply at towong.vic.gov.au**

**Corryong Indoor Bowls**

**Results R10 25/7/22**

Attackers d Pole Cats 22-6, CNC d Bacashes 17-15, Hoppers d Lucyvale 17-9, Courthouse d Bandits 20-10, Thoughla d St George 19-8, AFL d Indiettes 21-8.

**Ladder**

| A Grade    |    |      |
|------------|----|------|
| Courthouse | 32 | +65  |
| Thoughla   | 32 | +40  |
| Bacashes   | 30 | +58  |
| AFL        | 28 | +69  |
| B Grade    |    |      |
| Attackers  | 20 | 16   |
| Bandits    | 20 | +12  |
| CNC        | 20 | +9   |
| Lucyvale   | 18 | -23  |
| C Grade    |    |      |
| Indiettes  | 18 | -28  |
| Hoppers    | 16 | -23  |
| Pole Cats  | 4  | -122 |
| St George  | 2  | -72  |

**Draw R11 1/8/22**

AFL v St George 4, Indiettes v Bacashes 6, Thoughla v Courthouse 3, CNC v Hoppers 5, Bandits v Pole Cats 1, Lucyvale v Attackers 2.

**Men's Pairs Final:** Craig McKimmie & Ron Pynappels v Rohan and Brett Whitehead.

**Finals 8/8/22**



**High Country Darts**

**Results R11 26/7/22**

Possum Pointers d Brumbies 4-3, Bottom Pub d Tinpot 6-1, Biggara d Bottoms Up 4-3.

| Ladder     | P  | %     |
|------------|----|-------|
| Bottom Pub | 36 | 185.2 |
| Brumbies   | 36 | 133.3 |
| P/Pointers | 28 | 123.5 |
| Tinpot     | 20 | 113.9 |
| Bottoms Up | 8  | 63.8  |
| Biggara    | 8  | 45.3  |

Sharpshooters  
Highest peg: M Russell 111; Men's highest score: Paul Cox, 180; Ladies' highest score: Andrea Carmody 112.  
Draw: R12 2/8/22  
Bottom Pub v P/Pointers  
Brumbies v Bottoms Up  
Biggara v Tinpot/

**MEETINGS**

**CORRYONG BASKETBALL**

ANNUAL GENERAL MEETING  
COME JOIN US  
TOWONGSHIRE MEETING ROOMS (TBC)  
MONDAY 1ST AUGUST 7-9PM

**NEW COMMITTEE REQUIRED - ALL POSITIONS VACANT**



**Employment Opportunities**  
Please check our website for current employment opportunities: [www.corryonghealth.org.au/employment](http://www.corryonghealth.org.au/employment)  
"Corryong Health is an Equal Opportunity Employer; we encourage applications from Indigenous Australians, people with disabilities, young people and people from culturally diverse backgrounds"

Caring for the Upper Murray  
Together, strengthening the health of our community

**TENDERS**

**Request for Tender**

We are seeking a qualified contractor to undertake upgrade works on the Omeo Highway and La Fontaine Street intersection in Mitta Mitta.

Submissions close Monday 15 August.

**Visit towong.vic.gov.au**

**Send your sports reports and photos to: [editorial@corryongcourier.com.au](mailto:editorial@corryongcourier.com.au)**

# Upper Murray Sport

## Footy foes unite for cancer fight

The Corryong and Federal football netball clubs will kick goals both on and off the field during a special charity round for the Albury Wodonga Regional Cancer Centre Trust Fund this Saturday.

Senior football and netball players will wear specially coloured socks as part of Terry Socks it to Cancer, inspired by former Ovens and Murray star, Terry Greaves, who is receiving treatment for metastatic melanoma.

Corryong, as the home team, will wear pink while Federal will be in yellow, which reflect the colours of the Albury Wodonga Regional Cancer Centre Trust Fund.

Juniors will be encouraged to wear "crazy" socks and make a

donation.

Upper Murray Football Netball League operations manager, Nadia Edwards, said the league was proud to get behind Mr Greaves and the campaign to raise money and awareness for the cancer centre.

"We encourage everyone to dig deep and support a cause which no doubt, has touched the lives of many our players, supporters and volunteers," she said.

"The cancer centre is such an important facility for our region and we look forward to bringing attention to this great local cause through the brightly coloured socks."

Donations will also be collected from supporters at the gates.

Mr Greaves, of

Markwood, was first diagnosed with cancer 15 years ago and experienced the challenges of having to travel long distances to receive treatment in Melbourne.

In 2020, his cancer returned and he has since received monthly treatment in Albury.

Mr Greaves said he was passionate about raising money for the cancer centre because it is so important for people in the region to have access to treatment and facilities locally.

"I've experienced it first hand after having to travel to Melbourne every three months for five years," he said.

"It is so much more convenient and stress-free being able to travel

to Albury, which is just a two-hour return trip, compared to Melbourne which is six hours."

Terry Socks it to Cancer has been organised by Mr Greaves, in partnership with AFL North East Border.

All money raised stays helps fund new equipment, staff training and development, research and wellness programs at the Albury Wodonga Regional Cancer Centre.

To make an online donation visit <https://bit.ly/terrysocksittocancer>.

**Caption: Terry Greaves (centre) is inspiring local sports fans to get behind his cancer campaign.**

**Photo: Border Mail**



**Kelsey-Lee Barber has joined elite company after winning the javelin event at the World Championships.**

## Champ goes back to back

Australian javelin thrower, Kelsey-Lee Barber, has emulated runner Cathy Freeman as the only Australians to defend their World Athletic Championship titles.

Barber enhanced her reputation as a big game performer by posting a huge 66.91m throw in the

third round to secure her victory in Eugene, Oregon on Saturday.

The win comes on the back of her bronze medal at the Tokyo Olympics in 2021.

Barber arrived in Australia from South Africa during the Sydney Olympics in 2000 and lived in Corryong where

her uncle and aunt, Henry and Gail Spink, owned a dairy farm.

She competed in the discus for Corryong College up to regional level before moving to Canberra in 2007, where she switched to the javelin and started training with a coach.

## TEE TO GREEN

**Corryong**  
Cold and frosty mornings have brought beautiful sunshine for the past couple of weeks

Just a huge shout out again to the groundsmen on their ongoing work on the course which is looking great, even with the extra attention from the birds on the fairways.

Results for the last couple of weeks are as follows:-

18/7 9 hole stableford:  
Winner - Cheryl Smedley  
14 points; r/up Ilma Clarke  
13.

20/7 9 hole stableford:  
Winner - Ilma Clarke 17

points; r/up Ilma Findlay  
9.

26/7 Canadian:-  
Winners - Sue Morley & Ilma Clarke 36 on a count back from Cheryl Lloyd and Catherine Ross 36.

Special mention that the annual Spring Tournament - 4BBB will be held on Wednesday 14th September. More details will follow.

### Welaregang

After a wash out of the Captain's Trophy the previous Sunday, the previous Sunday, round 3 of the Monthly Medal stroke and putting competition attracted six starters last Sunday.

In one of his rare appearances this season, Phil Cribb was in rare form, carding an 88 off the stick (75 nett) to easily win the day and book his place in the final of this competition later in the year. The runner-up, Tony Jarvis, continued his consistent season with a 78 nett. The putting 'guru', Bill Bond, again won that prize with 24.

This Sunday players will compete for the Captain's Trophy in a Par event with the captain expecting a big turnout of members, with visitors also welcome.

## Visitor Information Centre Summit

### Help showcase our region!

**We're excited to showcase the tourism and business products our region has to offer as hosts of the 2022 High Country Visitor Information Centre (VIC) Summit.**

Front line staff and volunteers from across the Victorian High Country region and neighbouring New South Wales visitor information centres will gather at the Corryong Visitor Information Centre in October for the annual summit.

Programmed activities across the two-day event will include familiarisation tours running across the region and lunch to follow with guest speakers, prizes and more.

We're reaching out to encourage business operators across the Shire to contribute in any way to the success of this event by showcasing what our region has to offer.

If you're a tourism business and would like to express your interest in promoting our region contact Lizzie Star at the Corryong Visitor Information Centre on 02 6076 2277 or [vic@towong.com.gov.au](mailto:vic@towong.com.gov.au).

For more information visit [towong.vic.gov.au](http://towong.vic.gov.au)



# Upper Murray Sport

## Around the football/netball clubs



### Swans Nest

#### Football

Reserves:- It was a bit of a battle with limited numbers but everyone gave their all and played the game out to the end so well done.

Awards: \$30 - Malte Thieme; FFNC Stubby holder and cash award - Beau Butters; FFNC Polo - Jaye Gericke; FFNC Merchandise - Dylan Seglow.

Seniors:- It was a great game which we played it out to the finish. Daniel Hales was our best this week with Cameron Sheather and Ashley Greenhill playing good games as well. In defence, Harry Pole rucked tirelessly all day for another super game.

Awards: \$50 - Daniel Hales; UM Refrigeration Mug - Cameron Sheather; FFNC Stubby Holder & cash award - Ashley Greenhill; FFNC hat - Harry Pole.



Lachie Hampton escapes the clutches of Sam Harrison.



Cudgewa's Luke Bloom vies with Peter Whitty for the Sherrin.



### Blues News

#### Football

Seniors:- We had to fight hard all day to get the win but Darcy McKimmie and Jack Ross gave us plenty of drive out of the back line.

Yarrod Hamilton and Nick Brockley gave us options up forward and the debutants were absolutely fantastic attacking the footy hard while Kyle Jarvis was super at half forward, grabbing most opportunities that come his way.

Best: Jack Ross, Darcy McKimmie, Nick Brockley, Kyle Jarvis, Yarrod Hamilton.

Reserves: We had another good win with the aged but agile Brendan McEvoy setting up the win with eight goals in the first half. Jayden Pryse gave us the advantage from the ruck where John Cossor and Aaron Lezius sent the ball into the forward line all day.

Best: John Cossor, Aaron Lezius, Jayden Pryse, Brendan McEvoy.

U11s: It was a great win by the team in our 'grand final'. It is no secret that Feds are well coached by Sam and Neville. Both teams played awesome football with our crew coming out on top. Everyone played at their best. It was impossible

to pick out best players. The team learned one of footballs biggest lessons "a champion team will always beat a team of champions."

#### Netball

C Grade:- After a couple of rough weeks of sickness mixed with bye rounds the girls found a way to bounce back. Teamwork won the game for us on the day, being able to support each other to play our best against a really tough side.

Our shooters were on fire even with a tough defence from Federals. Eden Cook and Chloe Trompf stopped some crucial passes into the Feds' goal ring and seamlessly moved the ball back to our end score from turnovers.

Awards: Brooke Tregilgas, Eden Cook and Zoe McKimmie.

D Grade: We came away with a good win and the girls played together very nicely, supporting one another and showing strong discipline down the court. Chloe Land took out the players' player award which was so well deserved. Chloe, Jasmine Cane and Lalita Linklater put so much pressure on in defence, forcing turnovers giving the attack end lots of opportunities to convert, which they did nicely.

U15s:- We played a strong match against an undefeated Federals side.

They were beaten by only eight goals which was a great effort against a very disciplined opponent. Everyone worked really hard to keep in the game and the girls were really united throughout the match.

U11s: We played a wonderful game against Federals and worked hard for the entire game, listening to all advice given by the coaches and trying their best to put into play new skills. They worked well as a team and didn't drop their heads once.

Awards: Logan Nagy and Charlotte Klippel.



### Demons Den

#### Netball

U15s:- What a cracker of a game with only one or two goals separating the teams at each break. Our defensive pressure was fantastic giving our team scoring opportunities but Tumba's defence was also amazing so our girls had to work extra hard to get the scores on the board. Well down to our girls for working really hard all game and never giving up.

Awards: Hobie's Sport Store - Lauren Zimmer, Sportspower Albury - Abby Connor, Regent Cinema Albury - Bridget Bailey.

### UMFNL Ladders Football - Round 12

#### SENIORS

| TEAM       | W | L | D | P  | %      |
|------------|---|---|---|----|--------|
| Tumbarumba | 9 | 1 | 0 | 28 | 208.19 |
| Bullioh    | 7 | 2 | 0 | 24 | 134.09 |
| Cudgewa    | 6 | 4 | 0 | 20 | 179.15 |
| Federal    | 1 | 8 | 0 | 4  | 48.09  |
| Corryong   | 1 | 9 | 0 | 4  | 36.03  |

#### RESERVES

| TEAM       | W | L | D | P  | %      |
|------------|---|---|---|----|--------|
| Bullioh    | 9 | 0 | 0 | 36 | 546.94 |
| Tumbarumba | 7 | 3 | 0 | 28 | 132.92 |
| Cudgewa    | 6 | 4 | 0 | 24 | 121.67 |
| Corryong   | 2 | 3 | 0 | 8  | 82.01  |
| Federals   | 0 | 8 | 0 | 0  | 17.85  |

#### UNDER 14s

| TEAM       | W | L | D | P  | %      |
|------------|---|---|---|----|--------|
| Cudgewa    | 5 | 0 | 0 | 20 | 267.80 |
| Tumbarumba | 2 | 3 | 0 | 8  | 157.14 |
| Bullioh    | 0 | 4 | 0 | 0  | 14.53  |
| Corryong   | 0 | 0 | 0 | 0  | 0      |
| Federals   | 0 | 0 | 0 | 0  | 0      |

Advertising pays dividends  
**Corryong Courier**  
 Phone: 02 6076 1045  
[adverts@corryongcourier.com.au](mailto:adverts@corryongcourier.com.au)  
[editorial@corryongcourier.com.au](mailto:editorial@corryongcourier.com.au)

### UMF NL Ladders Netball - Round 12

#### A GRADE

| TEAM       | W | L  | D | F   | A   | P  | %     |
|------------|---|----|---|-----|-----|----|-------|
| Tumbarumba | 8 | 1  | 1 | 587 | 365 | 34 | 80.00 |
| Cudgewa    | 7 | 2  | 0 | 549 | 428 | 30 | 70.00 |
| Federal    | 5 | 4  | 1 | 367 | 341 | 20 | 55.56 |
| Bullioh    | 3 | 6  | 0 | 343 | 473 | 12 | 33.33 |
| Corryong   | 0 | 10 | 0 | 327 | 566 | 0  | 0.00  |

#### B GRADE

| TEAM       | W  | L | D | F   | A   | P  | %      |
|------------|----|---|---|-----|-----|----|--------|
| Cudgewa    | 10 | 0 | 0 | 571 | 333 | 40 | 100.00 |
| Tumbarumba | 6  | 3 | 0 | 371 | 328 | 28 | 66.67  |
| Bullioh    | 5  | 4 | 0 | 380 | 284 | 20 | 55.56  |
| Federal    | 1  | 8 | 0 | 199 | 392 | 4  | 11.11  |
| Corryong   | 1  | 8 | 0 | 267 | 451 | 4  | 11.11  |

#### C GRADE

| TEAM       | W | L | D | F   | A   | P  | %     |
|------------|---|---|---|-----|-----|----|-------|
| Tumbarumba | 9 | 1 | 0 | 347 | 159 | 36 | 90.00 |
| Bullioh    | 8 | 1 | 0 | 231 | 146 | 32 | 88.89 |
| Cudgewa    | 4 | 6 | 0 | 206 | 239 | 16 | 40.00 |
| Federal    | 2 | 7 | 0 | 164 | 238 | 8  | 22.22 |
| Corryong   | 1 | 9 | 0 | 146 | 312 | 4  | 10.00 |

#### D GRADE

| TEAM       | W | L | D | F   | A   | P  | %     |
|------------|---|---|---|-----|-----|----|-------|
| Tumbarumba | 6 | 1 | 0 | 159 | 88  | 24 | 85.71 |
| Bullioh    | 4 | 2 | 0 | 123 | 111 | 16 | 66.67 |
| Federal    | 2 | 5 | 0 | 105 | 137 | 8  | 28.57 |
| Cudgewa    | 2 | 6 | 0 | 115 | 166 | 8  | 25.00 |
| Corryong   | 0 | 0 | 0 | 0   | 0   | 0  | 0.00  |

#### 15 & UNDER

| TEAM       | W | L | D | F   | A   | P  | %      |
|------------|---|---|---|-----|-----|----|--------|
| Federal    | 9 | 0 | 0 | 205 | 89  | 36 | 100.00 |
| Bullioh    | 6 | 3 | 0 | 157 | 156 | 24 | 66.67  |
| Corryong   | 4 | 6 | 0 | 190 | 200 | 16 | 40.00  |
| Tumbarumba | 4 | 6 | 0 | 109 | 142 | 16 | 40.00  |
| Cudgewa    | 1 | 9 | 0 | 103 | 177 | 4  | 10.00  |

# kids' puzzles



PUZZLES AND PAGINATION ©  
**pagemasters.**  
Pagemasters | pagemasters.com

## Dot to dot

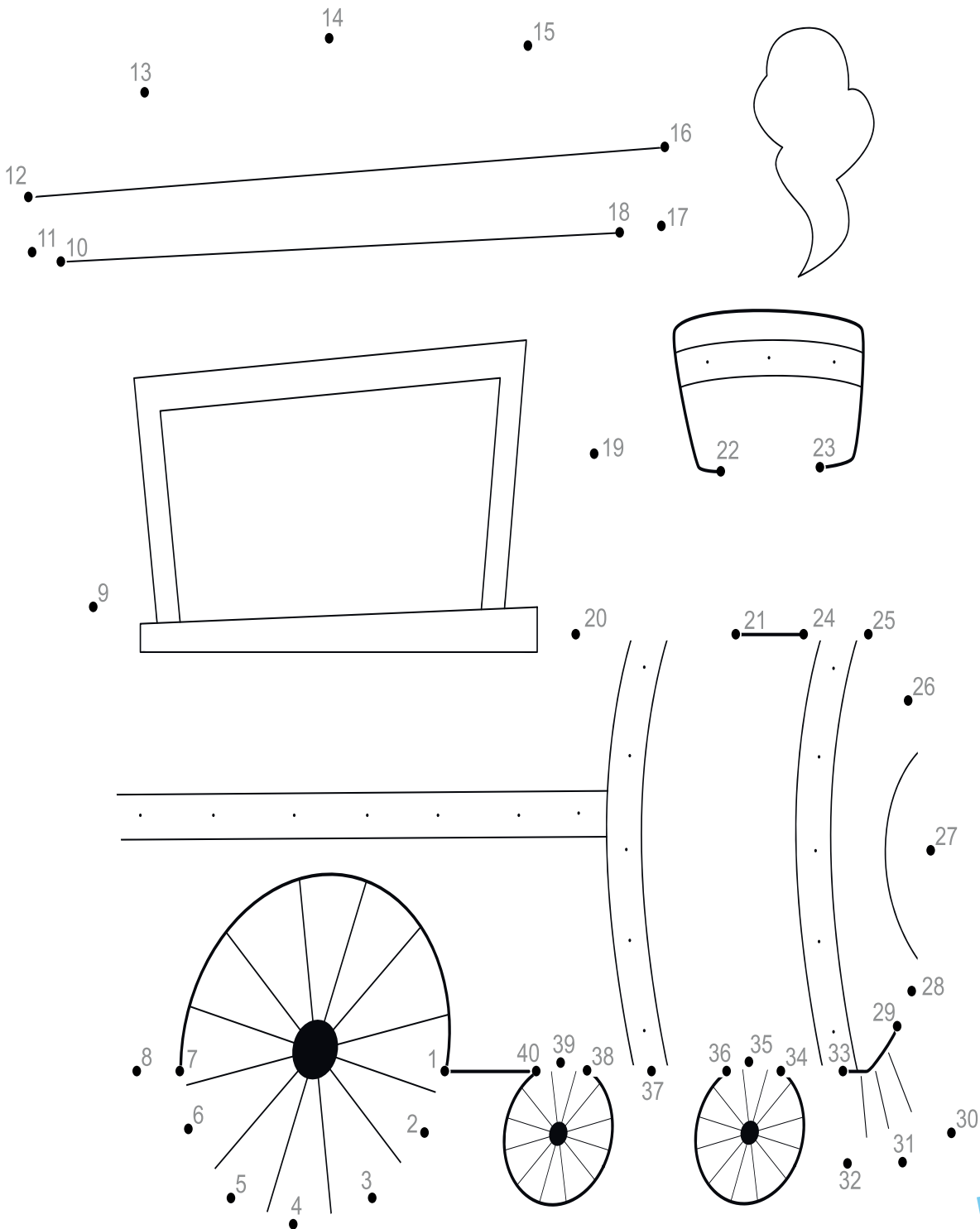

## Word find

Can you find all of the words listed?  
The leftover letters will spell out a message.

|   |   |   |   |   |   |   |   |   |   |   |
|---|---|---|---|---|---|---|---|---|---|---|
| M | H | K | S | B | A | B | U | R | T | N |
| D | O | E | E | Q | E | A | N | E | A | B |
| C | C | L | D | S | U | A | E | E | O | A |
| O | F | U | E | G | T | I | V | D | T | D |
| W | F | R | R | S | E | R | R | E | S | G |
| E | N | A | N | L | U | H | E | R | R | E |
| A | E | B | E | O | E | O | O | L | E | R |
| S | V | B | W | R | E | W | M | G | E | L |
| E | A | I | T | L | N | E | T | R | A | M |
| L | R | T | O | E | R | A | H | S | O | T |
| L | I | V | O | T | T | E | R | F | E | D |

- HEDGEHOG
- KESTREL
- MARTEN
- MOLE
- NEWT
- OTTER
- RABBIT
- RAVEN
- SQUIRREL
- STOAT
- VOLE
- WEASEL

- BADGER
- BEAVER
- CURLEW

- DEER
- DORMOUSE
- HARE

Secret message: Abundance of forest life

## Spot the difference

Can you find five differences between these images?



ANSWERS: 1. Fish 2. Stars 3. Mermaid cheeks 4. Castle entrance 5. Octopus spots

## Junior crossword

Solve all the clues and an eight-letter word will be spelled out.

- |   |  |
|---|--|
| 1 Push  | 7 Explode like a volcano                               |
| 2 Napped  | 8 Monopoly, Chess and Scrabble are examples of — games |
| 3 More ready to eat (fruit)                       |  |
| 4 Fruit drink                                     |  |
| 5 Mum's sisters                                   |  |
| 6 'I scream, you scream, we all scream for ice —' |  |

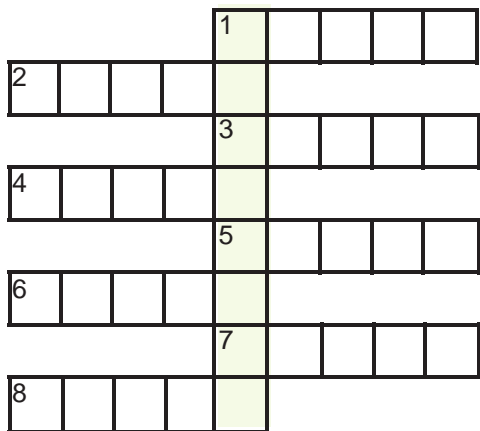

2807

ANSWERS: Shove, Slept, Riper, Juice, Aunt, Cream, Erupt, Board, (STREAMED)

## Quiz

- |   |  |
|---|--|
| 1 The <i>Mona Lisa</i> was painted by which artist?   | 6 How many babies are in a set of octuplets?   |
| 2 A phrase involving the tears of what animal can mean fake crying?   | 7 The Wallabies are the Australian national team for which sport?                    |
| 3 Red delicious, royal gala and pink lady are all types of what?  | 8 The Marvel superhero Thor (pictured) is loosely based on a god in which mythology? |
| 4 Which people were known for sailing in longships and raiding the British coast from the eighth to the 11th century? | 9 What is the gumtree more formally known as?  |
| 5 Mines in Central Australia are famous for producing which precious stone?   | 10 What is the name of Nemo's dad in <i>Finding Nemo</i> ?                           |



ANSWERS: 1. Leonardo da Vinci 2. Crocodile 3. Apples 4. Vikings 5. Opals 6. Eight 7. Rugby Union 8. Norse 9. Eucalyptus 10. Marlin

**IGA** plus LIQUOR  
24-30 Hanson St., Corryong.  
Ph: 6076 1286  
**Birthday Club**  
Ruby Maree Saunders  
August 5, 20138 (9)  
To register your child in the Birthday Club phone 6076 1045 or email [adverts@corryongcourier.com.au](mailto:adverts@corryongcourier.com.au)  
EACH BIRTHDAY CLUB MEMBER RECEIVES A BIRTHDAY CARD AND FREE PATTIES PARTY PACK

Advertising that pays dividends  
**Corryong Courier**  
Online advertising also available  
Ph: 02 6076 1045 / Email: [adverts@corryongcourier.com.au](mailto:adverts@corryongcourier.com.au)

# Services & Business Directory

## BEAUTY AND HEALTH

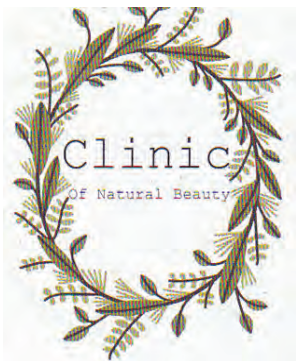

Appointment by phone  
 Phone Jane Mongan  
 0427 737 556

## BUS SERVICE



CORRYONG BUS & FREIGHT

### TIMETABLE

Daily service to Albury-Wodonga via Walwa  
 Monday to Friday

**Departs:**

|                                      |        |
|--------------------------------------|--------|
| Corryong Newsagency (6076 1381)..... | 7.30am |
| Cudgewa.....                         | 7.45am |
| Tintalra.....                        | 8.00am |
| Walwa Store (6037 1291).....         | 8.20am |
| Jingellic Store (6037 1320).....     | 8.45am |
| Mount Alfred.....                    | 9.00am |
| Granya.....                          | 9.30am |

**Arrives:**

|                          |         |
|--------------------------|---------|
| Snow White Depot.....    | 10.15am |
| (474 David St., Albury)  |         |
| Wodonga Post Office..... | 10.30am |
| (High St., Wodonga)      |         |

**Departs:**

|                          |        |
|--------------------------|--------|
| Wodonga Post Office..... | 1.30pm |
| Snow White Depot.....    | 2.00pm |
| (6021 4368)              |        |

**Arrives:**

|                          |        |
|--------------------------|--------|
| Granya.....              | 2.50pm |
| Mount Alfred.....        | 3.25pm |
| Jingellic.....           | 3.35pm |
| Walwa.....               | 3.45pm |
| Tintalra.....            | 4.00pm |
| Towong.....              | 4.10pm |
| Corryong Newsagency..... | 4.30pm |

• Pickup/drop off service available to railway stations, airport and hospitals.

**Enquiries: 0427 240 077**

• Bus service does not operate on weekends or Victorian public holidays.

## CARPET CLEANING

**WILESMITH CARPET & UPHOLSTERY CLEANING**

Free hallways and mats with house lots  
 Pensioner discounts available

Craig & Tanya Wilesmith  
 Our service and quality are guaranteed

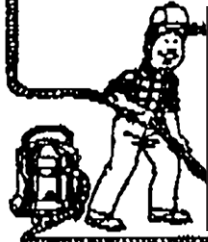

**PHONE:**  
**0428 482 976**  
 or contact local agent  
**Hobie's Sports Store**  
**6076 1121**

## COMPUTER SERVICES



For competitive prices and local services, systems (on site installation), software accessories and system maintenance. Call to discuss your requirements or for an obligation free quote.

**Warwick Ross**

Ph: 6076 2233 / Fax: 6076 1609

## CONCRETTERS

### HARRY'S CONCRETING

*For a Quality Finish*

- Shed Slabs • Pathways
  - Driveways • Patios
  - Exposed Stamp & Stencil
- Bobcat & Tipper Hire**  
**0439 400 418**

## EARTHMOVING & EXCAVATION

### HILLIER CONTRACTING

- ❖ Road Construction & Maintenance
- ❖ Road Re-sheeting
- ❖ Dairy Lanes
- ❖ Culvert & Drainage
- ❖ Site Cuts
- ❖ Building Pads
- ❖ Subdivisions
- ❖ Dam Construction & Cleaning

**PLANT HIRE**  
**Full Range of Quarry Products**

Phone: Office - 02 6076 1329

Greg - 0408 555 131 / Fax: 02 6076 2240

Email: hilliercontracting@bigpond.com

### R & S MCINNES EARTHMOVING

*Equipment for hire*

- 2 x 21 ton Volvo excavators
- Volvo 30 ton dump truck
- D6T CAT Bulldozer
- 10m Truck & Dog
- Cat 12G Grader
- Triaxle Float
- Log Grab
- 11 ton smooth & padfoot rollers



For all enquires please phone  
 Richard and Samantha on  
**02 6076 1446 or 0408 768 246**

## EARTHMOVING & EXCAVATION

### S & K WHITEHEAD EARTHMOVING P/L

- 3 x 20 Ton Excavators
- CAT D6T Bulldozer
- Komatsu D65 Bulldozer
- Komatsu 655 Grader
- Truck and Truck Trailers
- 25 Ton Dump Truck
- Rock Breaker
- Smooth Drum Roller
- Tri-axle Spread Float



### QUARRY PRODUCTS

- Road Base - 25mm & 40mm
- Rock for erosion control

For all your earthmoving needs

Simon & Kim Whitehead

Ph: 02 6076 2036 / 0408 495 468

## FARM REPAIRS & MAINTENANCE

Joe Elias T/A

### Joey's Repairs

On Site Services & Repairs

ABN: 59189416149

24 hrs 7 Days a week

- Trucks and Machinery
- Welding
- Auto Electrical
- 5 Tonne Excavator for hire



**Phone:**

**02 6077 1170**

**Mobile:**

**0429 110 264**



## MEDICAL SERVICES

### WALWA MEDICAL CLINIC

• Regularly visiting doctors

- ❖ Dr Barbara Hoare ❖ Dr Clare Rocznik
- ❖ Dr Ian Partridge ❖ Dr Stephanie Partridge
- ❖ Dr Susan Lumsdaine

- Same day appointments generally available
- Bulk billing for concession card holders & children 16yrs & under
- Blood/pathology tests

**Phone: 6037 1**

Appointments also available with Maternal Health Nurse.



If you have information about production of illegal drugs or any other criminal activity, phone Crime Stoppers Rural anonymously on

**1 800 333 000**

**1800 333 000**

# Services & Business Directory

# WHAT, WHEN & WHO

## PAINTER

**Dean Williamson**  
**PAINTING**  
 • Commercial & Domestic Work  
 • Repaint Specialist  
 • Free Quotes  
**PH: 0467 956 893**

## PLUMBING

**BROWNS PLUMBING**  
**CORRYONG**  
 Servicing the Upper Murray for over 30 years  
 Licence No. VIC 24675 NSW 214998C

- **PLUMBING**
- **GASFITTING**
- **DRAINAGE**



**COMMERCIAL & DOMESTIC**  
 Supply, installation & maintenance

- Gas & combustion stoves
- Carbon monoxide testing
- Wood & gas heaters
- Roofing & guttering
- Water tanks, water pumps & pressure systems
- Hot water services
- Evaporative air-conditioners
- Large range of PVC, copper pipe & poly fittings
- Sewer & drain cleaning machine
- Ditch Witch, backhoe/front end loader & horizontal borer
- Pipe & cable locator
- Backflow prevention

**Colin Brown's Mobile: 0409 742 476**  
 Workshop: 27-31 Harris Street, Corryong  
 rbbjbrown@bigpond.com

## PEST CONTROL



**HIGH COUNTRY**  
**PEST CONTROL**  
**All Pest Control Treatments**  
**Servicing all areas**  
 Brendon & Kerrie Attree  
 Lic. VIC/NSW  
 Mobile: 0418570194  
 Ph/Fax: 02 60725347  
 email: [highcountrypc33@gmail.com](mailto:highcountrypc33@gmail.com)  
 "When Local Knowledge Really Counts"

**Make your ADVERT**  
**stand out with a splash**  
**of colour for ONLY an**  
**extra \$10 a week.**

## TYRES

**Corryong Tyre & Auto**



**Gas Agent & Equipment Partner**



**Neuton POWER**  
 Revolution in Power

27 Donaldson Street, Corryong  
 Ph: (02) 6076 1177 / 0457 328 123 (AH)  
 E: [corryongtyre@hotmail.com](mailto:corryongtyre@hotmail.com)

**CLOSED SATURDAY MORNINGS**  
**Service by appointment only**

## Corryong Courier

Published by Moscol Group Pty Ltd  
 (ABN 23 154 875 573)  
 Shop 1 / 41 Hanson St, Corryong 3707  
 Printed by Newsprinters Pty Ltd - 1 McKoy Street, Wodonga, Vic 3690.  
 Circulation: 1100 (Stat. Dec.)

**CONTACT US:-**  
 Phone: 02 6076 1045  
 Email addresses:-  
 Editorial/news stories: [editorial@corryongcourier.com.au](mailto:editorial@corryongcourier.com.au)  
 For adverts (copy, bookings, remittances): [adverts@corryongcourier.com.au](mailto:adverts@corryongcourier.com.au)  
 For sport: [sport@corryongcourier.com.au](mailto:sport@corryongcourier.com.au)  
 Postal Address: PO Box 32, Corryong 3707

**DEADLINES:-**  
 Casual Display Advertising: By 5pm Friday  
 Classified Advertising: By 12 noon Monday  
 Editorial & Letters to the Editor - 12 noon Monday  
 General News - 12 noon Monday  
 Sports Results: - 12 noon Monday

**RATES:-**  
 Casual Advertising: \$5.17 per cm / single column (discounts available for multiple insertions)  
 ¼ Page - \$198; ½ Page - \$324.50; Full Page - \$583.  
 Colour negotiable. Long term contract rates also available.  
 Classifieds: \$5.44 + \$1.59 per line (min. 4 lines). Payment required at time of placement  
 Inserts: \$148.50 per 1,000 (All prices include GST)

**COPYRIGHT:** All advertising and editorial content of this issue is the copyright of Moscol Group Pty Ltd and cannot be used without the company's permission.

**COMPLAINTS:** The *Corryong Courier* is bound by the Standards of Practice of the Australian Press Council.

**Important numbers**  
 Police: Corryong 02 6076 1666

## MUSEUM ROSTER

**Winter Hours**  
**1pm-4pm daily**  
**July 29:** R Waters  
**July 30:** C Clark  
**July 31:** G Bennetts  
**Aug 1:** S Briskey  
**Aug 2:** S Briskey  
**Aug 3:** Help wanted  
**Aug 4:** Help wanted

## OP SHOP

**July 29:** am Hazra, pm Petrina Hewatt & Sam Nicholas;  
**July 30:** am Tully;  
**Aug 1:** am Di Brennan, pm Dianne Macdonald;  
**Aug 2:** am & pm Barbara & Bob Brown;  
**Aug 3:** am Corryong College Students, pm Chris Harrison & Jane Spilsbury;  
**Aug 4:** am Sam Pryse, pm Hazra;  
**Aug 5:** am & pm;  
**Aug 6:** am Kim Heycox.

## MEALS ON WHEELS

**ROTARY**  
 1/08/22 - 5/08/22

## CORRYONG HEALTH



## VACCINATIONS

People aged 12 or above can pre-book via one of the following methods in the Sub-hub which operates each Wednesday from 9am - 4:00pm:

- Calling Corryong Health on 02 6076 3200 and putting your name on the list. You will receive a call back from the sub-hub staff between Tuesday and Thursday to schedule your vaccination time; or
- Calling the National Covid Hotline on 1800 675 398; or
- Web booking: <https://portal.cvms.vic.gov.au/Urgent-Care-Centre> (UCC):- Present to the UCC / Be assessed by highly trained nurse / If required a doctor will be contacted via My Emergency Doctor

Other Services:-  
 Emergencies - 000  
 Corryong Medical Clinic - 02 6076 3290  
 Corryong Health Reception - 02 6076 3200  
 Nurse on Call - 1300 606 024 (anytime)  
 GP Helpline - 1800 022 222 (anytime)  
 Pathology - Mon. to Frid. 8am to 12pm.

## TOWONG SHIRE & PUBLIC LIBRARY

76 Hanson St., Corryong  
 Council customer service and library staff are available Monday to Friday 9am to 4.30pm. Council office and library are closed on weekends and public holidays. Ph: Shire: 6076 2160 / Library: 6076 1639

## UPPER HUME HEALTH SERVICE

Alcohol, Tobacco and Other Drugs support - drug withdrawal nurses and counsellors from Wodonga will visit on an outreach basis as required. Ph: 1800 657 573.

## WASTE MANAGEMENT

### Corryong Tip

Thursday: 3pm - 5pm  
 Sunday: 12 noon - 4pm  
 Public holidays - Closed  
**Waste Collection Days:**  
**Tuesday:** Towong, Tintaldra, Walwa, Jingellic, Lucyvale, Colac Colac  
**Thursday:** Cudgewa Valley, Cudgewa, Nariel, Thougla, Biggara, Bunroy  
**Friday:** Corryong Township, Khancoban.  
 For more information visit [www.towong.vic.gov.au](http://www.towong.vic.gov.au) or phone 02 6071 5100 or 1300 365 222 (local call cost).

## LOCAL POLICE

**For all emergencies call Triple Zero - 000**  
 For non-urgent matters call the Police Assistance Line (24/7) 131 444  
 Corryong 02 6076 1666

## CENTRELINK

Retirement: 132 300; Disability/Sickness & Carers: 13 2717; Multilingual Service: 13 1202; Customer Relations: 1800 050 004; Appointments: 13 10 21. Carelink: 1800 052 222.

## BREASTFEEDING SUPPORT

National Breastfeeding helpline 1800 686 268. Local volunteer counsellor - Lisa Vallett 0459 707 085. Info at [www.breastfeeding.asn.au](http://www.breastfeeding.asn.au).

## CORRYONG FOODSHARE

Open Wednesday and Thursday 9am-1pm  
 Call in and pick up what you need or call Carol on 0427 762 051 for home delivery.  
 Water & household items - call Douglas on 0427 014 935.

## CATHOLIC PARISH

Mass Times:- 2nd and 4th Sundays of the month  
 • Christ the King, Walwa - Saturday Vigil at 4pm  
 • Sacred Heart, Corryong - Sunday at 8:30am

## COMMUNITY CAR

A service for those without transport to access appointments in Alb-Wodonga. Ph: 6076 3200.

## BAPTIST CHURCH

**89 Hanson Street**  
**Enquiries:**  
 Pastor Graeme Van Brummelen - (02) 60761 468 / 0488 269 393  
 Service time: 10am  
 Kids church: 10.30am  
 Youth Group: during school term Friday nights at 7pm  
 'Mainly Music': a program for babies to preschool children and their carers - Wednesdays 10.30am  
 Ring Kirsty for details 0411 524 442

## ANGLICAN PARISH

Eucharist at All Saints Corryong 9:30am - every Sunday  
 Eucharist at Biggara 2pm - 1st Sunday  
 Eucharist at Holy Trinity Cudgewa 8am - 3rd Sunday  
 Combined Service at All Saints Corryong 10.30am followed by fellowship - 5th Sundays  
 Enquiries: Rev Maryann Leonard on 02 6076 1057 or 0439 066 553.

## PENTECOSTAL

**Ambassadors of Jesus**  
 59 Donaldson Street  
**Sunday:** 10.30am Worship & The Word followed by Fellowship Lunch.  
**Wednesday:** 7.45pm: Alternate Fellowship - Ladies, Prayer, Men's, Family.  
**Enquiries:** Pastors Douglas & Carol Allen 6076 2050 /51. Fax 6076 2052.E-mail: [aoj@corryong.net](mailto:aoj@corryong.net).  
**Catch The Fire Ministries & Rise Up Australia** Prayer Meeting: 7.45 pm Sunday: First of the month at Council Chambers, Corryong  
**Enquiries:** B Cadle 6948 4468

## UNITING CHURCH

Services are held at 9.30am each Sunday, except 5th Sundays, which are at Walwa 11am.  
 Cnr Donaldson & Wheeler St., Corryong  
**Regional Minister:** Rev. Andrew Delbridge 0410 663 194  
**Church Council:** Linda Nankervis 0488 339950  
**Pastoral Enquiries:** Sandy Hill 6076 8273, Catherine Ross 0408 648 467, Linda Nankervis 0488 339950  
**Hall Hire:** Pamela Menere 0408 767 327

## SEVENTH DAY ADVENTIST

**Saturday Service:**  
 Uniting Church Hall, Corryong at 9.30am.

## LOCAL JUSTICES OF PEACE

Carol Allen - NSW & Vic. (6076 2051); Merv Ward (6076 1369); Phil Coulston (6071 2746); Tom Newton - Vic (0438 382 140); Terry Forrest (0499 579 502).

# Upper Murray Sport

## Favourites follow the script

The two matches went as expected in local football on the weekend but Tumberumba's mammoth score against a 14-man Corryong team came out of the blue. The main destroyer was Roos' spearhead

Daniel Hitchens who booted 13 goals on his return to the side after several weeks absence. The Demons held their own in the first quarter thanks to the Roos' poor kicking on goal but the rout started in the second

term when Tumba warmed up with seven goals and then put the pedal to the metal after the long break to slam on eighteen majors to the Dees' three.

Mitch Palmer, Connor Clayton and Jake Read ran riot in the huge win while Corryong was best served by Dylan Nowak and Pat Riley who are likely to fight out the Demons' best and fairest award.

With at least eight regulars sidelined, Cudgewa still posted a comfortable victory over a wayward Federal, with Nick Brockley kicking five goals to retain his position at the top of the *Corryong Courier* goalkicking award.

The Blues started well with six goals in the first stanza but the Swans lifted in term two and should

have been closer at the half except for inaccuracy in attack.

However, with Jack Ross, Darcy McKimmie and Brockley winning out in most contests Cudgewa did enough to edge away to 50-point victory.

Fed's big men Ash Greenhill and Harry Pole were competitive in the air and Dan Hales and Lachie Hampton benefited when the ball hit the deck but the Swans were outmanoeuvred around the ground to run out of petrol tickets in the last quarter.

**Results 12**  
**Football Seniors**  
**Tumberumba v Corryong**  
 Tumberumba 3.9, 10.17, 20.20, 28.28 (196)  
 d Corryong 2.1, 2.2, 3.3, 5.4 (34).

Goals:- Tumberumba - D Hitchens 13, D Rixon 3, J Read 3, M Palmer 3, G McEachern 2, S Chaffey, J Munday, P Hussell, K Hall. Corryong - J Palmer 2, P Riley.

Best:- Tumberumba - Mitch Palmer, Connor Clayton, Jacob Read, Jim Waters, Henry Waters, Daniel Hitchens. Corryong - Dylan Nowak, Pat Riley, Jordan Palmer, Evan Nicholas, Angus Pilli, Ryley Cain.

**Reserves**  
 Corryong forfeited to Tumberumba.

**Federal v Cudgewa**  
 Cudgewa 6.1, 9.3, 12.8, 15.12 (102) d Federal 2.3, 3.7, 6.8, 7.10 (52).

Goals (11/15):- N Brockley 5, B Hall 3, L Whiteley, Y Hamilton, D McKimmie. Federal - H Pole 2, M Pieper, J Miller, P Whitty, C Tyrell, L Hampton.

Best:- Cudgewa - Jack Ross, Darcy McKimmie, Nicholas Brockley, Kyle Jarvis, Yarrod Hamilton.

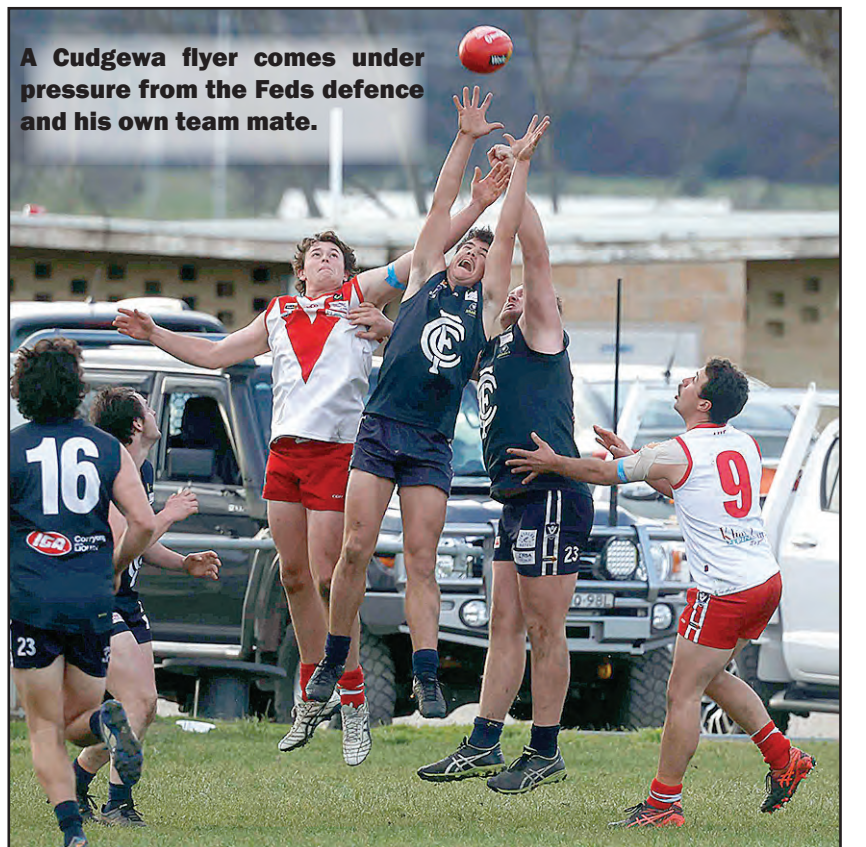

A Cudgewa flyer comes under pressure from the Feds defence and his own team mate.

Federal - Daniel Hales, Cameron Sheather, Ashley Greenhill, Harry Pole, Michael Linklater, Lachlan Hampton.

**Reserves**  
 Cudgewa 9.3, 17.7, 22.11, 26.16 (172) d Federal 1.0, 2.0, 3.2, 4.5 (29).

**Corryong Courier Goalkicking Award Seniors**

N Brockley (Cu)..... 52  
 D Hitchens (Tu) ..... 48  
 T Lampe (Tu) ..... 28  
 M Haley O'Neill (Bu).. 27  
 B Hall (Cu)..... 27  
 S Price (Bu)..... 25  
 K Morey (Cu)..... 19  
 H Schubert (Bu)..... 12  
 J Crozier (Tu)..... 12  
 G Wheeler (Cu)..... 11  
 J Vinge (Cu)..... 11

**Netball 15&Under**

Federal 20 d Cudgewa

12  
 Tumberumba 18 d  
 Corryong 15

**D Grade**  
 Cudgewa 24 d Federal 17

**C Grade**  
 Cudgewa 20 d Federal 15

Tumberumba 40 d  
 Corryong 19

**B Grade**  
 Cudgewa 66 d Federal 34

**A Grade**  
 Cudgewa 39 d Federal 34

Tumberumba 83 d  
 Corryong 24

**This week - R13**  
 It's not often that a clash between the two bottom placed teams would qualify as match of the round but that is the

case this Saturday when Corryong and Federal meet in the local derby with a finals berth at stake.

The record between the two this season is one win apiece - against each other - but the Swans are favoured to take the honours, purely on the basis that they will have a full complement of players as opposed to the Demons who have struggled to field a full team in recent weeks.

Meanwhile, Bullioh will host Tumberumba in a probable preview of the second semi final and will be keen to see how they stack up against the ladder leaders but the Roos are flying at the moment and if their attack includes both sharpshooters in Daniel Hitchens and Tyler Lampe, the Dogs will be in for a tough day.

**AUCTIONEERS - LIVESTOCK**  
 Contact your local agents  
**Jeff Brindley 0428 762 554**  
**Will Jennings 0447 766 503**  
 Office: 02 6058 1234  
**Paull & Scollard** **Nutrien**  
 Ag Solutions

**CP corcoran parker**  
 LIVESTOCK • REAL ESTATE • MERCHANDISE

- Livestock Agents
- Rural Property Marketing

We provide the following services:

- Livestock
- Paddock Sales
- Corryong Liveweigh Scales
- Wodonga Market Sales
- Property
- Obligation free appraisals
- Auctions, Private Sales & Tenders
- Clearing Sales

Livestock: Nick Houston 0427 111 453  
 Cameron Hilton 0419 578 309  
 Property: John Honeychurch 0419 790 924  
 Talk to us TODAY about your Livestock & Property requirements

**We know**  
**Calf Nutrition, Probiotics & Supplements**



**Electro-G**  
 Electro-G – hi-performance electrolyte supplement. Supplies rapid energy and corrects dehydration.



**Kwik Start**  
 Fast acting, immune building, "Real Bovine Colostrum" for new borns.



**BioCalf**  
 Probiotic Calf Milk Additive  
 High performance, micro-encapsulated & multi-strain non-antibiotic calf milk additive powder.



**BioBoost – Probiotic Paste**  
 Multi-strain probiotic paste promotes immunity, recovery and improves digestion

**Agmate Rural Services**  
 33 Donaldson Street, Corryong VIC 3707 Ph: 02 6076 1166  
 There's always better value at CRT.  
 www.crt.com.au

